

SPORTABLE SCOREBOARDS®

INSTALLATION INSTRUCTIONS FOR

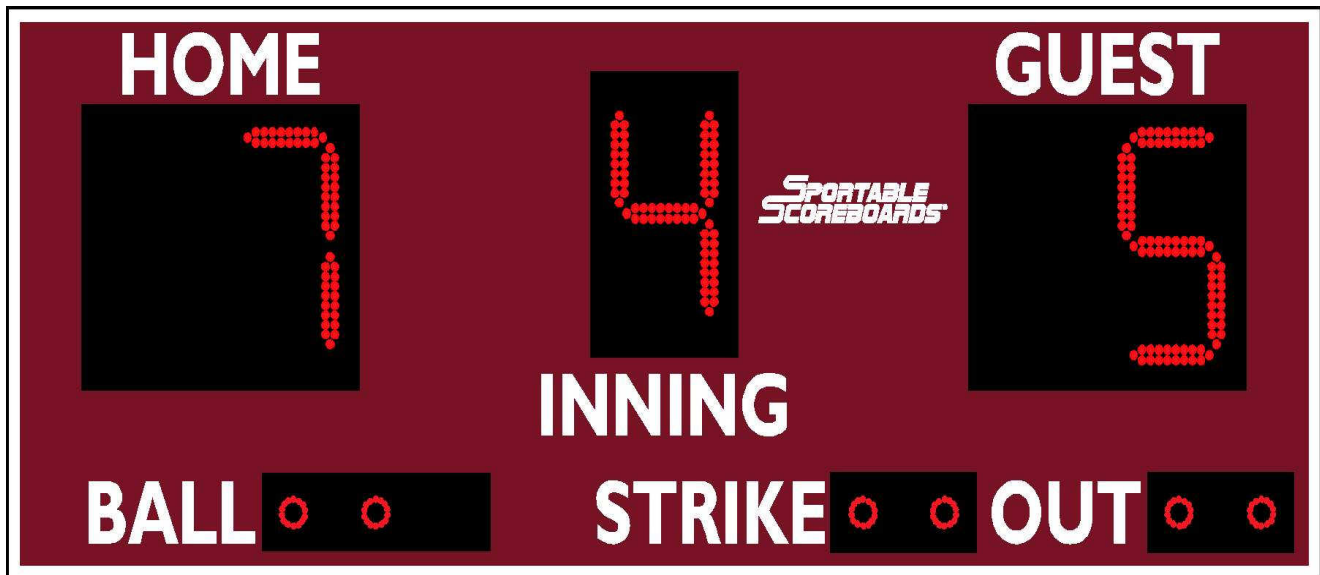

MODEL 3308 LED

www.sportablescoreboards.com

Table of Contents

DESCRIPTIONS.....	3
THE SCOREBOARD SYSTEM SHOULD INCLUDE THE FOLLOWING PARTS:.....	3
INSTRUCTIONS FOR REPORTING SHIPPING DAMAGE	3
INSTALLATION OVERVIEW.....	4
PRODUCT SPECIFICATIONS	4
Overall Dimensions:.....	4
Weight:	4
Mounting Recommendations:	4
Power Requirements:	4
Cable Recommendations (for cable-controlled systems only):	5
DETERMINING LOCATION AND ORIENTATION.....	5
INSTALLING MOUNTING POLES OR I-BEAMS.....	5
MOUNTING THE SCOREBOARD	6
RUNNING & CONNECTING THE CONTROL CABLE.....	9
At the scorekeeper’s location:	Error! Bookmark not defined.
At the scoreboard:	Error! Bookmark not defined.
RUNNING & CONNECTING THE ELECTRIC SERVICE	13
TESTING THE INSTALLED SYSTEM	16
Testing the scoreboard system:.....	16
IMPORTANT!.....	17
Warranty Activation/Installation & Completion Sign Off Sheet	17

DESCRIPTIONS

3308 LED SCOREBOARD

NOTE TO INSTALLERS: PLEASE RETURN THIS MANUAL TO THE INDIVIDUAL IN CHARGE OF THE SCOREBOARD UPON COMPLETION OF INSTALLATION.

The scoreboard and all accompanying accessories have been carefully inspected and tested before leaving the factory. However, it is possible for damage to have occurred during shipping so we ask that you inspect all shipping containers upon arrival for damage and ensure that you have all of the parts listed below. If you find that damage has occurred during shipping, **DO NOT** refuse the shipment. Instead, accept the shipment from the carrier, follow the instructions for filing a freight damage claim found below, and notify the manufacturer immediately.

THE SCOREBOARD SYSTEM SHOULD INCLUDE THE FOLLOWING PARTS:

ITEMS IN LARGE PACKAGE(S)

- (1) 3 -ft. x 8'-ft. Baseball Scoreboard, shipped in (1) section

ITEMS IN ACCESSORY BAG

- (1) Handheld controller
- (1) CD ROM (including installation, operation, maintenance, warranty, and support information)

Cable-controlled systems (standard):

- (1) 20-ft. control cable
- (1) Junction box covers with built-in 5-pin din socket
- (1) Customer-specified length of control cable

Wireless systems (optional):

- (1) Wireless transmitter – built-in to the controller

INSTRUCTIONS FOR REPORTING SHIPPING DAMAGE

Shipping damage must be noted at the time of delivery. Consignee must note "DAMAGED" on the Delivery Receipt Form. Please make notations of the type of damage to the freight and to the packaging. Ask the delivery driver to call the local terminal and report immediately. The shipper is **not responsible** for the shipments that are not signed for as damaged upon arrival. Please contact the manufacturer immediately to report the damage. The shipper is responsible for filing the claim, unless shipped 3RD Party.

If damage is discovered after delivery, call the delivery company to report the concealed damage and please call the manufacturer immediately to report. Concealed damage must be reported within 5 days after delivery date. If the damages are found after this time, the manufacturer will not be responsible.

INSTALLATION OVERVIEW

This manual will walk you through the installation of the scoreboard. While care has been taken to consider the many scenarios for installation, some general information applies to all. Use this guide as closely as possible to ensure proper installation, as follows:

1. Review the product specifications below to determine your specific installation hardware.
2. Determine the scoreboard's location and orientation.
3. Install the mounting poles/I Beams (supplied by the customer).
4. Mount the scoreboard to the poles/I Beams (**mounting hardware supplied by customer**).
5. Install the control cable for cable-controlled systems (**not necessary for Wireless Remote Control systems**).
6. Install the electrical service for the scoreboard and the controller.
7. Install any options, such as sponsor panels or protective nets, according to the installation instructions included with each option package.
8. Test the installed system.
9. Fax/return warranty activation sheet to Scoreboard Service Company at (270) 753-3773.

PRODUCT SPECIFICATIONS

Overall Dimensions:

3' - ft x 8' - shipped in one (1) section

Weight:

Hanging weight = approximately 160 lbs
Shipping weight = approximately 200 lbs.

Mounting Recommendations:

(2) 8" steel I-beams (W8 x 31) **OR** (2) 8" OD galvanized steel poles (schedule 40), total length determined by local codes, customer preferred mounting height, and scoreboard options.

Power Requirements:

Scoreboard:

(1) 120-volt, 20-amp, 60 Hz grounded AC circuit connected to a power disconnect switch or circuit breaker (refer to the wiring diagram on page 9 for instructions on determining the scoreboard's power requirements – specific power requirement information is also marked on the scoreboard's serial number label, located on the scoreboard)

Hand held controller:

Will be powered through the communication cables from the scoreboard terminated at the connection at the wall cover plate.

Cable Recommendations (for cable-controlled systems only):

Four conductor cable – 28 gauge, twisted pair (two pairs), shielded data cable

DETERMINING LOCATION AND ORIENTATION

The scoreboard should be positioned so that the greatest number of spectators can easily view it. Also, consider the best orientation of the scoreboard should the system be used to score a daytime or afternoon game. The scoreboard should be positioned so that sunlight does not glare off of its face. In the U.S., placement on the South or West side of the field is recommended. Consult with the local building or zoning department before final determination and installing the scoreboard.

INSTALLING MOUNTING POLES OR I-BEAMS

NOTE: The following information for installing the mounting poles/beams are suggestions only. Local codes, field placement, scoreboard options, customer preference, and other special considerations will determine the specifics of your installation, including footer specifications, above ground height, and total length of the poles/I-beams.

1. Install the two (2) mounting poles/I-beams (supplied by the customer) on the field with a 4' center spacing and with 13'-6" (*) of pole/I-beam above ground (refer to the figures below).

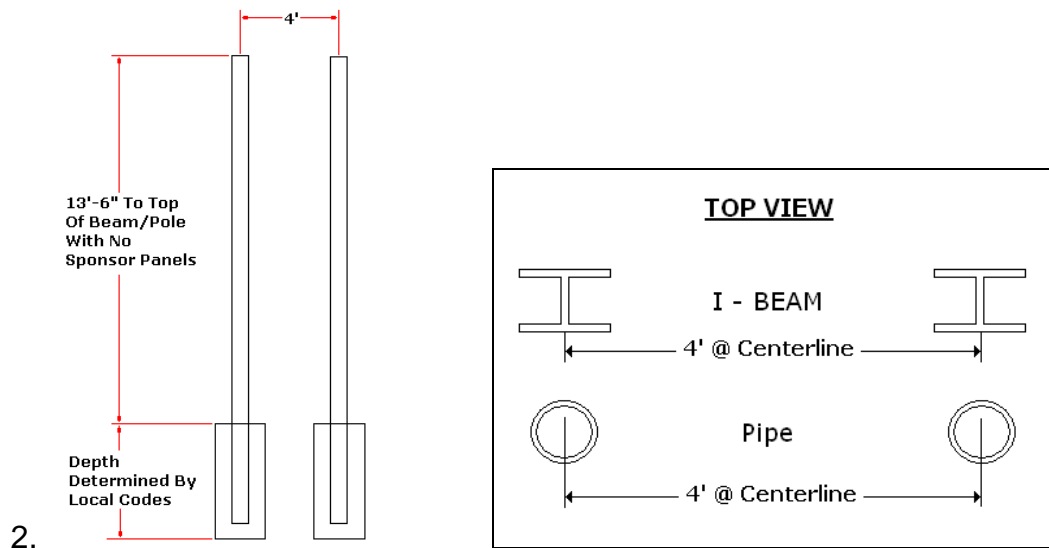

3. The poles/I-beams must be set into concrete footers. Make sure the poles are level and plumb and spaced on 4' centers. The mounting faces of I-beams must be straight with each other. If the faces of an I-beams are not flush with each other, shims will be needed to mount the scoreboard. The required dimensions for the footers vary depending on local building codes, soil & weather conditions, and scoreboard size. Consult with local building

officials for the required pole sizes and footer construction regarding this installation. A local architect, structural engineer, or sign installer may also be a source of assistance.

IMPORTANT: DO NOT MOUNT THE SCOREBOARD TO A WALL. A MINIMUM OF 18” – 24” CLEARANCE MUST BE MAINTAINED FOR ACCESS TO THE BACK OF THE SCOREBOARD CABINET. CONTROL MODULE, POWER, AND SIGNAL CABLE CONNECTIONS ARE ACCESSED ON THE BACK OF THE SCOREBOARD.

MOUNTING THE SCOREBOARD

NOTE: IF THE POLES/I-BEAMS ARE NOT IN ALIGNMENT --- SHIMS MAY BE NEEDED TO MOUNT THE SCOREBOARD PROPERLY. MOUNTING THE SCOREBOARD WITH THE POLES/I-BEAMS OUT OF ALIGNMENT MAY DAMAGE THE SCOREBOARD AND VOID THE WARRANTY.

1. Using the lift holes provided, connect a lift device to the scoreboard, as in the image below.

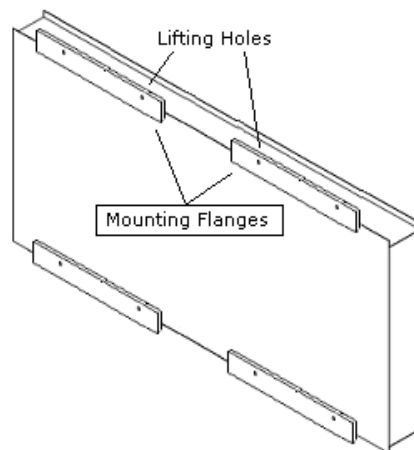

- 2.
3. Lift the scoreboard into place to the desired height, ensuring that the scoreboard is level.
4. Secure the scoreboard to the poles/beams using the mounting flanges attached to the scoreboard. The unit must be attached to each pole/beam on top **and** bottom.
5. If using steel I-beams, either weld the mounting flanges to the supports, or drill the mounting flanges and supports to use bolts, washers, and nuts to secure the scoreboard to the I-beams.
6. If galvanized steel poles are being used, weld or bolt steel angles to the mounting flanges, which can then be welded to or bolted *through* the pole. Refer to the figure below for detailed illustrations of these suggested mounting methods.

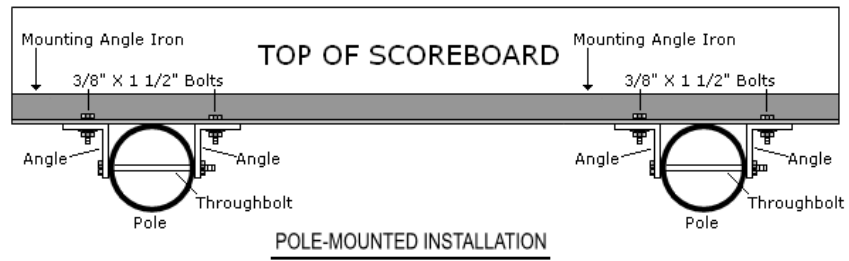
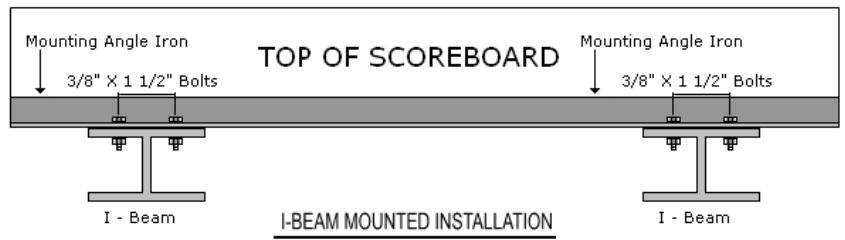

NOTE: MOUNTING HARDWARE SUPPLIED BY CUSTOMER

Scoreboard Dimensions:
3' tall x 8' wide x 8.0" depth

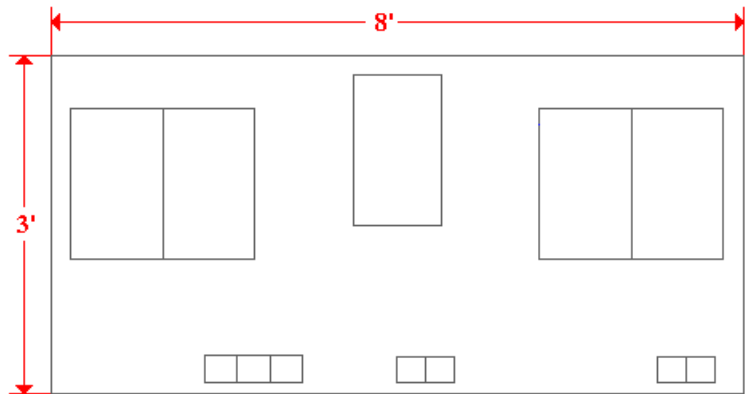

Front View: Mounted

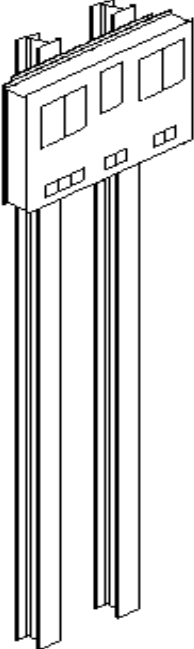

Rear View: Mounted

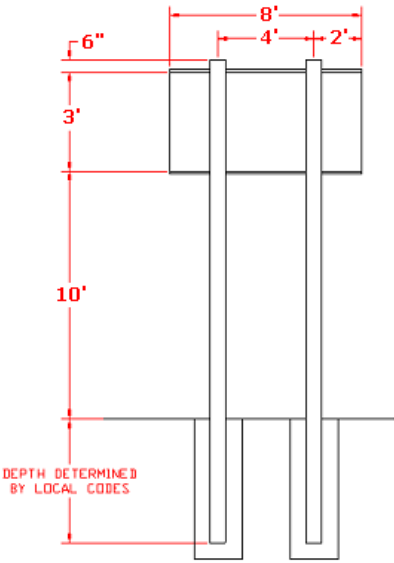

RUNNING & CONNECTING THE CONTROL CABLE

(For scoreboards with Wireless Remote Control, skip this step.)

The control cable must be run in a separate conduit than is used for the electrical service. The control cable should run from the scoreboard to a location that is within 10 feet of the scorekeeper's location and into a 2"X4" wall box.

AT THE SCOREKEEPERS LOCATION:

1. With the communication cable installed between the scoreboard and the 2"X4" wall box, locate the wall plate provided with your installation hardware.

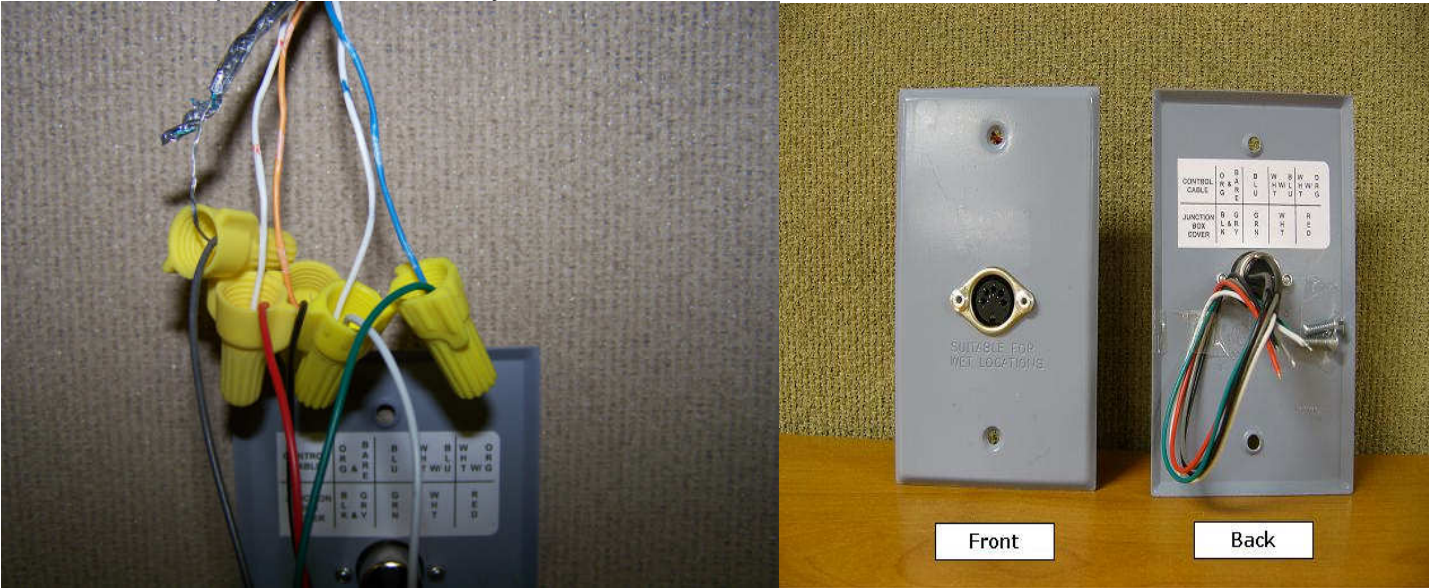

JUNCTION BOX COVER AT SCOREKEEPER'S LOCATION

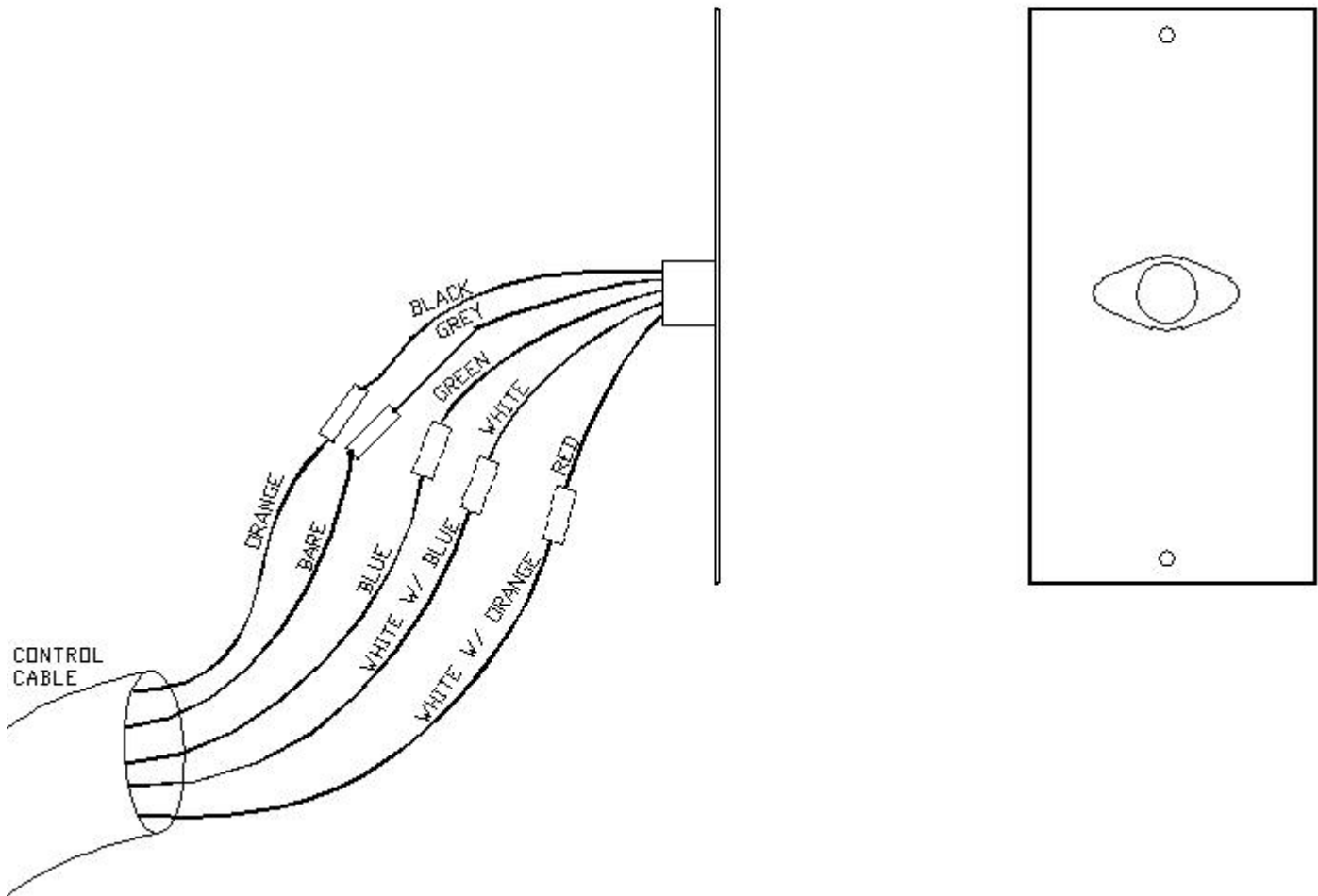

2. The back of the wall plate has a label indicating how the connections are to be made. As follows connect the black wire on the wall plate to the orange wire, connect the gray wire on the wall plate to the bare (shield) wire in the cable, connect the green wire on the wall plate to the blue wire of the cable, connect the white wire of the wall plate to the white with a blue stripe of the cable. **This is for a hand held controller only to connect the red wire to the white with orange stripe wire of the cable.** To prevent confusion it is recommended to have purchased the cable with the scoreboard, other cable may not be suitable for the installation giving false errors or communication problems between the controller and the scoreboard.

3. Secure the junction box cover to the installed junction box.

At the scoreboard:

4. Remove the signal/power access door located on the back of panel A.

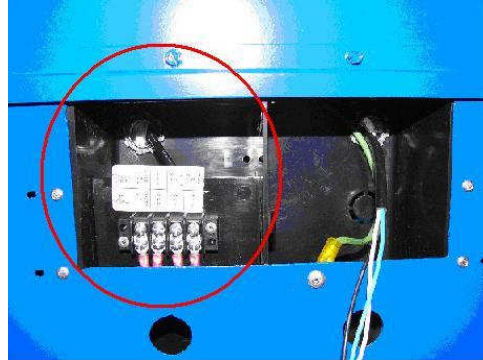

5. From the ground, run the control cable through a sealed, water-tight conduit then through a water-tight conduit fitting into the left side of the signal cable/power access door and into the scoreboard. A hole is provided for a conduit connector
6. Inside the scoreboard, connect the control cable leads to the appropriate terminals on the terminal block, according to the label above the terminal block. The connections are as follows connect the orange and bare wire of the cable to the terminal block opposite the black & gray wire connection, connect the blue wire of the cable to the terminal block opposite the green wire connection, connect the white with blue stripe of the cable to the terminal opposite the white wire connection. Do not connect the white with the orange stripe of the cable UNLESS YOU ARE USING A HAND HELD CONTROLLER THIS CONNECTION WILL HAVE TO BE MADE AS FOLLOWS: Connect the white with orange stripe of the cable the terminal opposite the red wire connection. MAKING THIS CONNECTION USING A LARGE CONTROLLER WILL BURN THE CONTROLLER OUT. If you need assistance call 800-411-3136.

SIGNAL/POWER ACCESS DOOR ON SCOREBOARD

WIRE FROM
SCOREKEEPERS
LOCATION

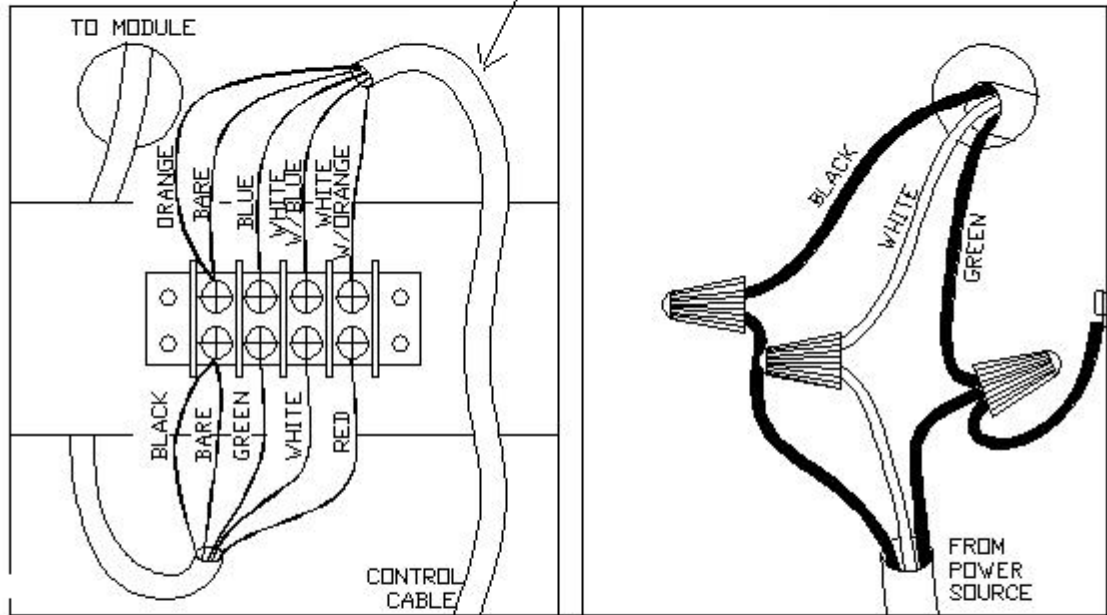

7.

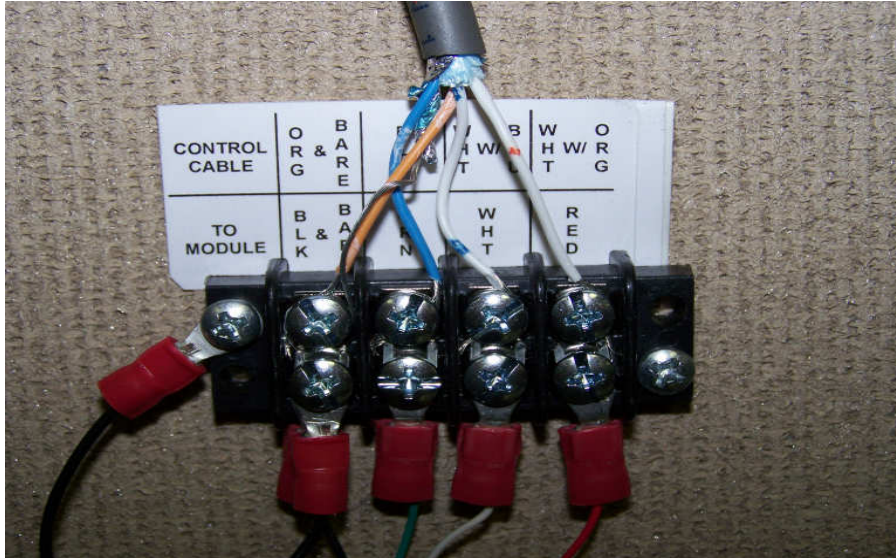

NOTE: Refer to the connections that were made at the scorekeeper's location. Make the connections at the scoreboard match the connections at the scorekeeper's location.

8. Re-secure the signal/power access door to the scoreboard.

RUNNING & CONNECTING THE ELECTRIC SERVICE

NOTE: IT IS RECOMMENDED TO HAVE A LICENSED ELECTRICIAN FOR THIS PORTION. IDEALLY, THE SCOREBOARD WILL BE POWERED FROM A DEDICATED 120-VOLT / 20 AMP CIRCUIT. ADDITIONALLY, SINCE THE SCOREBOARD'S POWER SHOULD BE TURNED OFF AFTER EACH USE, THERE SHOULD BE EASY ACCESS TO THE POWER SWITCH OR CIRCUIT BREAKER. IF ACCESS TO THE CIRCUIT BREAKER IS NOT AN OPTION, INSTALL A SWITCH SOMEWHERE THAT IS ACCESSIBLE, EVEN IF UNDER THE SCOREBOARD AT AN ABOVE AVERAGE HEIGHT.

1. The scoreboard has a ½" knock-out on the lower right corner for bringing in the electrical service. It can be enlarged if the conduit size is ¾". This is where the conduit from the power source needs to terminate.

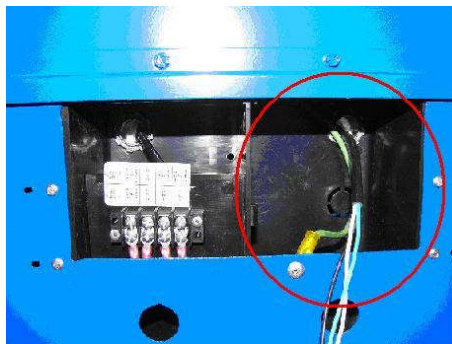

2. The connections are standard black, white, and green (ground). Replace the cover when complete.

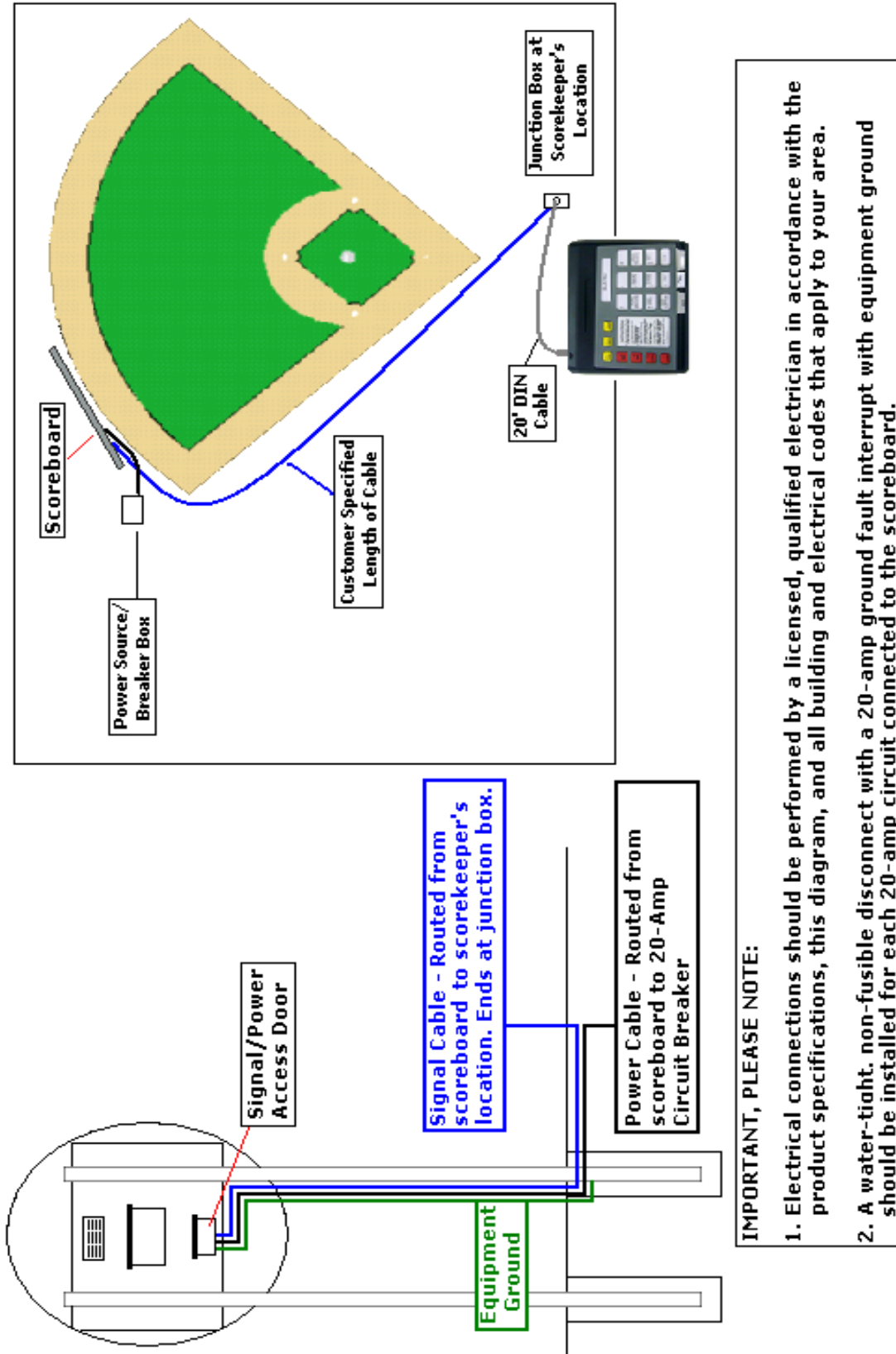

TESTING THE INSTALLED SYSTEM

NOTE: Please refer to the OPERATORS MANUAL on the CD, or included with the system to operate the scoreboard.

Testing the scoreboard system:

1. Turn the power to the scoreboard *ON* using the power disconnect switch or circuit breaker.

The controller has an LED indicator on the top left corner. This indicator should blink any time a key is pressed.

If your scoreboard is a cable system, verify that all cable connections are properly terminated and that the 20' supplied cable is properly connected on both the back of the controller and at the junction box.

If your scoreboard is a wireless system, verify that the batteries inside the handheld controller have sufficient voltage for operation. There are four (4) AA batteries that supply power to the controller during wireless operation. Together, they should have a minimum of 3.12 Volts in order to operate the controller.

2. The **HOME SCORE** should display a "5" for about three seconds (indicates "baseball mode"), and then both the HOME and GUEST scores should display a "0", while the INNING shows a "1". BALL, STRIKE, and OUT indicators will be blank. If the HOME score does not show a "5" any time the scoreboard is first turned on, follow these steps:

1. Press the SELECT GAME key and hold it for three (3) seconds.
2. Press the INNING Key (#5 key on the keypad).
3. Press the OUT Key (#9 key on the keypad) to store the selection.
4. Press NEW GAME to begin game play.

3. Use the controller keys to verify that all sections of the scoreboard respond properly.

Example: Add scores to both teams, increase Innings, Balls, Strikes, and Outs.

4. If the scoreboard displays a flashing "8" in the Inning position, this is either an indication of no signal communication between the scoreboard and controller, or simply an extended period of inactivity with the controller. The timeout period is one hour. If the time is less than that, check all communication cable connections and press NEW GAME on the controller. If the flashing "8" remains, contact Technical Support.

NOTE: Always turn both the controller and the scoreboard *OFF* after each use. If the controller is turned *OFF* but the scoreboard remains *ON*, (or if the controller loses communication with the scoreboard), the scoreboard's INNING digit will begin to flash with the rest of the displays blank. This feature is intended to remind the user to turn power to the scoreboard *OFF* after each use.

NOTE: To activate your warranty, your check off sheet must be signed and returned/faxed to Sportable Scoreboards Inc. A copy of this sheet should be placed with your Installation/Operators Manual in the event technical support is needed. Fax number (270) 753-3773.

IMPORTANT!

Warranty Activation/Installation & Completion Sign Off Sheet

NOTE: This sheet must be completely filled out and returned/faxed (270) 753-3773 to Scoreboard Service Company before your warranty can be activated.

Your Serial Number _____

Your Model Number _____

Date Purchased _____

Sales Agent _____

Person Authorizing Purchase (title) _____

Date Installation Completed _____

Company or Person Responsible
For Installation (address/phone number) _____

This document confirms that the installation for the 3-ft.x 8-ft. Baseball Scoreboard has been completed. All structural, wiring, and power requirements have been met. This unit has been tested in scoring and diagnostic modes, ensuring the functionality of the unit.

Scoring/timing equipment responsible party

Installer

So that we may better serve you, please have this information available in the event you need to call technical support. Customer Service: 1-800-411-3136