

# SPORTABLE SCOREBOARDS®

## INSTALLATION INSTRUCTIONS FOR

<b>BALL</b> 3	<b>STRIKE</b> 0	<b>OUT</b> 2								
<small>SPORTABLE SCOREBOARDS®</small>	1	2	3	4	5	6	7	8	9	<b>TOTAL</b>
<b>GUEST</b>	0	0	1	0	0	0				01
<b>HOME</b>	0	0	4	0	1					05

**MODEL 3320 LED**

[www.sportablescoreboards.com](http://www.sportablescoreboards.com)

# Table of Contents

DESCRIPTION.....	3
THE SCOREBOARD SYSTEM SHOULD INCLUDE THE FOLLOWING PARTS:.....	3
INSTRUCTIONS FOR REPORTING SHIPPING DAMAGE .....	3
INSTALLATION OVERVIEW.....	4
PRODUCT SPECIFICATIONS .....	4
Overall Dimensions:.....	4
Weight: .....	4
Mounting Recommendations: .....	4
Power Requirements: .....	4
Cable Recommendations (for cable-controlled systems only): .....	5
DETERMINING LOCATION AND ORIENTATION.....	5
Helpful Installation Tips: .....	5
INSTALLING THE MOUNTING POLES/BEAMS.....	6
DETERMINING INSTALLATION .....	7
ASSEMBLING AND MOUNTING THE SCOREBOARD .....	7
Installation:.....	7
RUNNING/CONNECTING THE CONTROL CABLE.....	9
At the scorekeeper’s location: .....	9
At the scoreboard: .....	10
RUNNING/CONNECTING THE ELECTRICAL SERVICE.....	11
TESTING THE INSTALLED SYSTEM .....	13
Connecting cable-controlled systems: .....	13
Connecting wireless systems:.....	13
Testing the scoreboard system:.....	13
IMPORTANT!.....	14
Warranty Activation/Installation & Completion Sign Off Sheet .....	14

# DESCRIPTION

## 8' X 20' OUTDOOR SCOREBOARD

### MODEL 3320 LED

**NOTE TO INSTALLERS: PLEASE FILL OUT AND SIGN THE INSTALLATION/WARRANTY FORM ON THE LAST PAGE OF THIS MANUAL AND RETURN THE MANUAL TO THE INDIVIDUAL IN CHARGE OF THE SCOREBOARD UPON COMPLETION OF INSTALLATION.**

The scoreboard and all accompanying accessories have been carefully inspected and tested before leaving the factory. However, it is possible for damage to have occurred during shipping so we ask that you inspect all shipping containers upon arrival for damage and ensure that you have all of the parts listed below. If you find that damage has occurred during shipping: **DO NOT refuse the shipment, follow the instructions below for filing a freight damage claim, and notify the manufacturer immediately at 1-800-411-3136**

**THE SCOREBOARD SYSTEM SHOULD INCLUDE THE FOLLOWING PARTS:**

**ITEMS IN LARGE PACKAGE(S)**

- (1) 8' x 20' scoreboard; shipped in five (5) sections
- (2) 20' mounting angle irons and hardware (nuts, bolt, and washers)

**ITEMS IN ACCESSORY BAG**

- (1) Keyboard controller with keypad inserts
- (1) 12-volt DC wall transformer
- (1) CD ROM (including installation, operation, maintenance, warranty, and support information)

**Cable-controlled systems (standard):**

- (1) 20-ft. control cable
- (1) Junction box covers with built-in 5-pin din socket
- (1) Customer-specified length of control cable

**Wireless systems (optional):**

- (1) Wireless transmitter with interface cable attached
- (1) Mounting bracket for transmitter

**OPTIONAL PARTS**

- (1) 31" X 20' sponsor panel(s) shipped in two (2) sections each
- (2) 10' sponsor panel mounting angle irons
- (5) Sponsor panel mounting brackets and hardware (included with each sponsor panel)

## INSTRUCTIONS FOR REPORTING SHIPPING DAMAGE

Shipping damage must be noted at the time of delivery. Consignee must note "Damaged" on the Delivery Receipt. Please make notations of the type of damage to the freight and to the packaging. Ask the delivery driver to call the local terminal to report the freight damage immediately. The shipper is not responsible for the shipments that are not signed for as damaged upon arrival. Please contact the manufacturer immediately to report the damage. The shipper is responsible for filing the claim, unless shipped 3RD Party.

If damage is discovered after delivery, call the delivery company to report the concealed damage and please call the manufacturer immediately to report the damage at 1-800-411-3136. Concealed

damage must be reported within 5 days after delivery date. If the damages are found after this time, the manufacturer will not be responsible for damage.

## INSTALLATION OVERVIEW

This manual will walk you through the installation of the scoreboard. While care has been taken to consider the many scenarios for installation, some general information applies to all. Use this guide as closely as possible to ensure proper installation, as follows:

1. Review the product specifications below to determine your specific installation hardware.
2. Determine where to install the scoreboard and install the mounting poles/beams
  - a. **NOTE: ALL HARDWARE REQUIRED TO MOUNT THE SCOREBOARD TO POLES OR I BEAMS IS SUPPLIED BY THE CUSTOMER.**
3. Arrange scoreboard panels for the assembly process.
4. Install sponsor panels if applicable.
5. Install the control cable for cable-controlled systems. No additional installation is necessary for Wireless Remote Control systems.
6. Install electrical system.
7. Install any other options; such as protective nets or horns, according to the installation instructions included with each option package.
8. Test the installed system.

## PRODUCT SPECIFICATIONS

### Overall Dimensions:

8'-0" tall x 20'-0" long x 8" deep; shipped in five (5) sections

### Weight:

Hanging weight = approximately 995 lbs. - Shipping weight = approximately 1,250 lbs.

### Mounting Recommendations:

(2) 8" steel I-beams (W8 x 31) or (2) 8" OD galvanized steel poles (schedule 40). Total length determined by local codes, mounting height, and scoreboard options.

### Power Requirements:

#### Scoreboard

(1) 120-volt, 20-amp, 60 Hz grounded AC circuit connected to a power disconnect switch or circuit breaker (refer to the wiring diagram on page 8 for instructions on determining the scoreboard's power requirements – specific power requirement information is also marked on the scoreboard's serial number label, located on the scoreboard)

#### Keyboard Controller

(1) 120-volt, 15-amp, 60 Hz grounded AC circuit in a standard duplex outlet (optional if an internal battery pack was purchased with the controller or using a handheld controller)

## **Cable Recommendations (for cable-controlled systems only):**

Four conductor cable – 28 gauge, twisted pair (two pairs), shielded data cable

# **DETERMINING LOCATION AND ORIENTATION**

The scoreboard should be positioned so that the greatest number of spectators can easily view it. Also, consider the best orientation of the scoreboard should the system be used to score a daytime or afternoon game. The scoreboard should be positioned so that sunlight does not glare off of its face. In the U.S., placement on the South or West side of the field is recommended. Consult with the local building or zoning department before final determination and installing the scoreboard.

## **Helpful Installation Tips:**

1. When removing the scoreboard from its packaging, do not pry against or cut into the scoreboard. Cut the packing straps and remove the box.
2. Inspect the unit for shipping damage according to the instructions on page 1.
3. Each piece of the provided 20' X 3.5" angle iron has two holes provided for a lifting shackle or clevis. Choose one of the 20' angle iron as the top mounting angle iron. Ensure that the pin for your clevis will pass through those holes. If not, it is easier to make changes before going further, whether a smaller clevis or a larger hole is required.
4. When installing the poles/I-beams that support the scoreboard, it is important to keep the spacing accurate and the faces straight. If you are using beams, a good way to keep the faces straight is to clamp a length of the 20' X 3.5" angle to the first and middle beams and the middle and third beams as they are placed, and if necessary, provide bracing until the concrete has cured. The poles/beams should be allowed to stand overnight for the concrete to cure enough to support the scoreboard.
5. Arrange 6 each 2" X 4" X 8' boards into two rows, three in each row, roughly seven feet apart on the ground in front of where you are to install the scoreboard. This will serve as a "table" for assembly and helps to keep the face of the scoreboard off of the ground. If the scoreboard uses wireless communication, remove the antenna from the panel it is mounted on until the scoreboard is mounted.

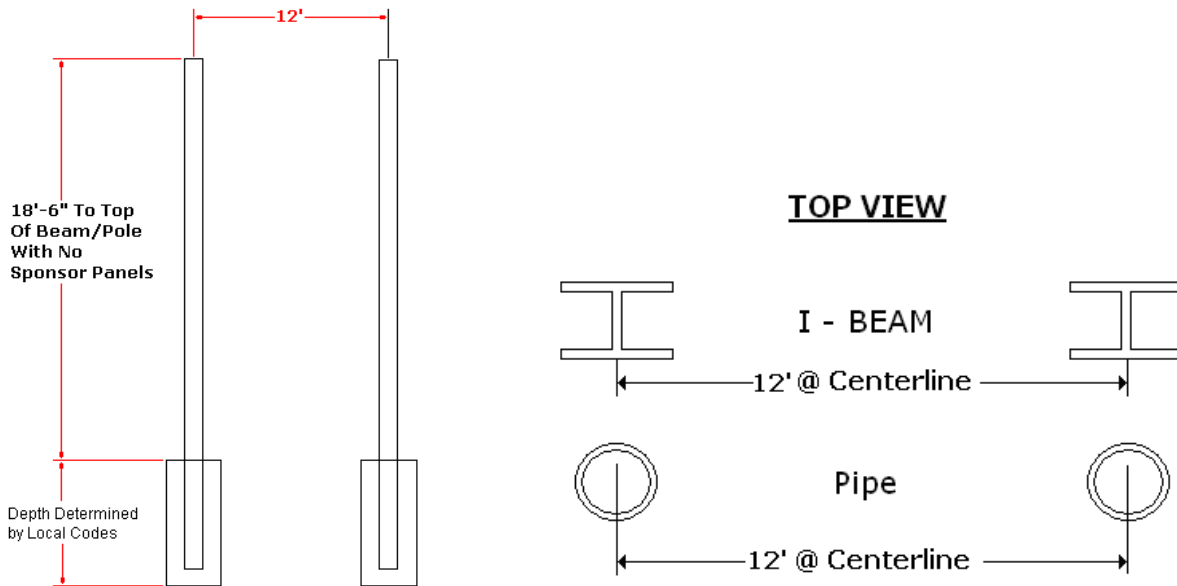

**NOTE: The length of Beam/Pole above ground should be calculated by including the height of top and/or bottom sponsor panels if they are part of the installation.**

## INSTALLING THE MOUNTING POLES/BEAMS

1. The following information for installing the mounting poles/beams is for suggestions only. Local codes, field placement, scoreboard options, customer preference, and other special considerations will determine the above ground height and total length of the poles/beams. The center to center pole/beam spacing should not be changed.
2. Install the two (2) mounting poles/beams (supplied by the customer) on the field 12'-0" (twelve feet, zero inches) center to center with 18'-6"(\*) of pole/beam above ground (refer to the installation diagram below). If a sponsor panel is to be mounted above the scoreboard, leave 21'-0" (\*) of pole/beam above ground (an additional 30").
3. The poles/beams must be set into concrete footers.
4. When installing the poles/I-beams that support the scoreboard, it is important to keep the spacing accurate and the faces straight.
5. The poles/beams should be allowed to stand overnight for the concrete to cure enough to support the scoreboard.
6. Make sure the poles are level and plumb. If the face of a pole/beam (either at the top or bottom of the mounting points of the scoreboard) is not straight, shims will be needed to continue the installation.
7. The required dimensions for the footers vary from city to city and state to state depending on the soil conditions, scoreboard size, and the building and sign codes for your area. Consult with local building officials for the required pole sizes and footer construction regarding this installation. A local architect, structural engineer, or sign installer may also be a source of assistance.

NOTE: CONSULT WITH LOCAL BUILDING CODE OFFICIALS REGARDING THE REQUIRED DIMENSIONS AND CONSTRUCTION OF THE FOOTERS, POLE/BEAM SIZES, AND OTHER REQUIREMENTS AND RESTRICTIONS REGARDING THE INSTALLATION OF THE SCOREBOARD.

## DETERMINING INSTALLATION

**IMPORTANT NOTE:** The main consideration when choosing installing is whether the lifting device you will use is capable of supporting the weight of the entire assembly. Your lift should be capable of lifting 1500 pounds in order to use Install this scoreboard. We do not recommend using this lifting device if it is borderline of supporting the total weight or if the lift will not be stable during the lifting process.

NOTE: Determining the installation method is the responsibility of the installer.

## ASSEMBLING AND MOUNTING THE SCOREBOARD

**IMPORTANT:** DO NOT MOUNT FLAT TO A WALL. A MINIMUM OF 18" CLEARANCE MUST BE LEFT FOR ACCESS TO THE REAR OF THE UNIT, AS THE ELECTRONIC MODULE ACCESS AND ALL POWER AND SIGNAL CABLE ACCESS DOORS ARE LOCATED ON THE BACK OF THE SCOREBOARD. 24" CLEARANCE IS RECOMMENDED. ALL HARDWARE REQUIRED TO MOUNT THE SCOREBOARD TO POLES OR I BEAMS IS SUPPLIED BY THE CUSTOMER.

### Installation:

1. After unpacking the scoreboard, arrange the panels in order A – E from left to right, face down, with the top away from the mounting poles or I beams. Keep the panels aligned at the top and against each other, making sure not to pinch cables that may be hanging outside of each cabinet.
2. Join the cabinets using the 3.5" X 20' mounting angle and the 3/8" bolt hardware provided in the installation kit, making one assembly.
3. Install crossover nipples between cabinets. **Failure to install crossover nipples will void the warranty.** Connect wiring in each of these sections.

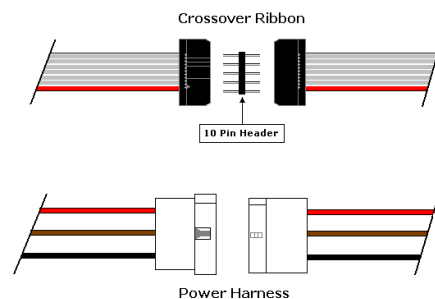

4. Connect ALL crossover cables between cabinets as in the image on the right above, making sure the red stripe on the edge of the ribbon cables are aligned when connected.
5. Lift the assembly from the top angle irons to a vertical position, still resting on the ground and install the top sponsor panel if included in the installation. Install the 2" X 8" flat steel brackets with the bolts provided in the pre-drilled holes along the top of the sponsor panel, with the bracket being perpendicular to the scoreboard, as shown below in the figure on the right.

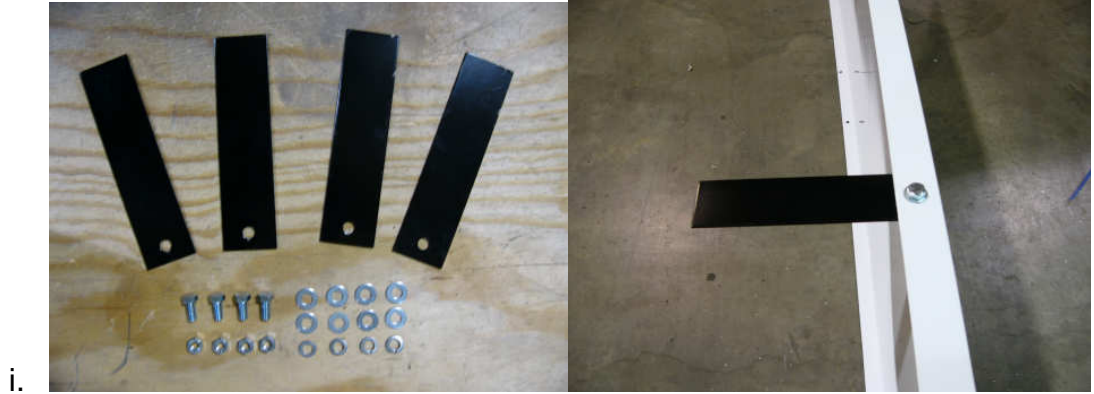

6. Lay two pieces of the 1.5" X 1.5" X 20' angle in the top channel of the scoreboard. These will be installed after the scoreboard is mounted.
7. Pick the scoreboard up high enough to install the bottom sponsor panel if included in the installation. Repeat the bracket assembly process from Step 5.
8. Raise the scoreboard to the mounting poles or I Beams and at the proper height, use a clamp at one pole or I beam to hold that corner in place.
9. Using a level in the top channel of the scoreboard, slowly raise the scoreboard to level it and clamp to the other end mounting pole or I Beam.
10. Weld or bolt the mounting angle to the poles or I Beams you are clamped to and follow the same procedure at the bottom of the scoreboard, clamp and weld or bolt. Follow by welding or bolting the angle to the center pole or I Beam at the top and bottom. It may be necessary to use clamps here as well.
11. At the top sponsor panel, clamp the two 1.5" X 1.5" X 20' angle to the I beams or poles level with the top of the sponsor panel and weld or bolt them to the poles or I Beams.
12. Weld or bolt the sponsor panel brackets that were fastened to the sponsor panels in Step 5 to the 1.5" angle, making sure to check for straightness along of the top edge of the sponsor panels before welding.
13. Repeat Steps 11 and 12 for the bottom sponsor panel.
14. Install any options such as horns or protective screens.
15. Run and connect the control cable for cable controlled systems. No cable is required for wireless systems.



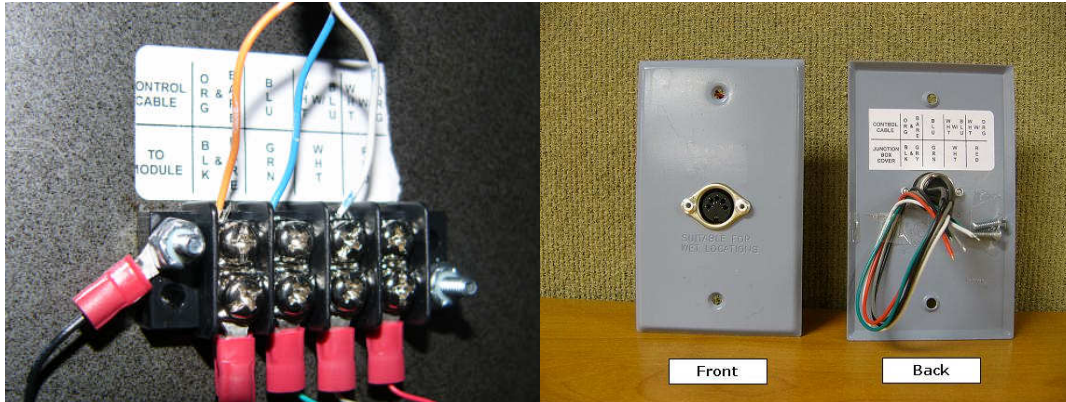

**NOTE: IF THE WIRES IN YOUR CABLE DO NOT COLOR MATCH WHAT IS SHOWN ABOVE, CONNECT TO THE TERMINALS WITH THE BLACK, GREEN, AND WHITE CONDUCTORS. DO NOT CONNECT A WIRE TO THE RED TERMINAL. MATCH THE SAME COLORS IN YOUR CABLE TO THE BLACK, GREEN, AND WHITE WIRES ON THE BACK OF THE WALL PLATE AT THE SCORING LOCATION.**

16. Run and connect the electrical system for the scoreboard and controller.
17. Replace the antenna on the front of the scoreboard if your system is wireless.
18. Test the installed system.
19. Install access covers on the rear of the scoreboard.
20. Fax/Return the Warranty Activation Form to Scoreboard Service Company at 1.270.753-3773

## **RUNNING/CONNECTING THE CONTROL CABLE**

**(For scoreboards with Wireless Remote Control, skip this step.)**

The control cable may be buried with or without conduit if the cable is direct burial-rated. Direct burial-rated cable in conduit is recommended for extended trouble free use. If the cable is not direct burial-rated cable, then it must be buried in a sealed, watertight conduit. The same is true for the electric cable powering the scoreboard. Both cables may be buried in the same trench but they must be kept at least 6" apart. If conduit is required for both, separate conduits must be used.

The control cable should run from the scoreboard to a location that is within 10 feet of the scorekeeper's location. Here, the supplied junction box cover should be installed on a 2x4, single-gang junction box. The keyboard will connect to the receptacle on the junction box cover via the included 20-ft. control cable.

At the scorekeeper's location:

1. Bring the control cable into a 2x4 single-gang junction box located within 10 feet of the scorekeeper.
2. Connect the leads inside the control cable to those on the junction box cover according to the label on the junction box cover. Refer to the installation diagram on the following page for more information.

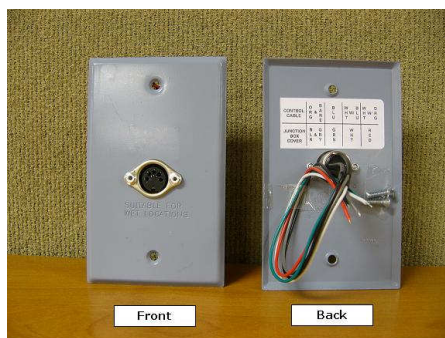

i.

3. **NOTE: IF THE WIRES IN YOUR CABLE DO NOT COLOR MATCH WHAT IS SHOWN ABOVE, CONNECT TO THE TERMINALS WITH THE BLACK, GREEN, AND WHITE CONDUCTORS. DO NOT CONNECT A WIRE TO THE RED TERMINAL. MATCH THE SAME COLORS IN YOUR CABLE TO THE BLACK, GREEN, AND WHITE WIRES ON THE BACK OF THE WALL PLATE AT THE SCORING LOCATION.**
4. Secure the junction box cover to the installed junction box.

At the scoreboard:

1. Remove the signal/power access door located on the back of panel A. For access door location, refer to the diagram on the following page.
2. From the ground, run the control cable through sealed, rain tight conduit then through a rain-tight conduit fitting into the left side of the signal cable/power access door and into the scoreboard.
3. Inside the scoreboard, connect the control cable leads to the appropriate terminals on the terminal block, according to the label above the terminal block.

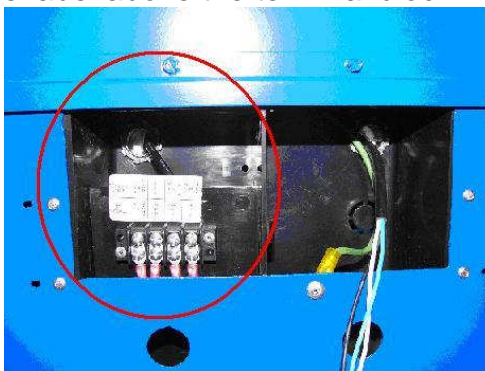

4.

5. **NOTE:** If the colors of the wires in the control cable differ from those referenced on the label or shown in the following diagrams, refer to the notes you made when connecting the control cable to the junction box cover at the scorekeeper's location. Ensure that each lead on the junction box cover is connected to the same color lead on the scoreboard terminal block, regardless of the color(s) of the wires in the control cable that connect them.
6. Re-secure the signal/power access door to the scoreboard.

**NOTE:** Even if the control cable was not buried in conduit, it must be run in sealed, watertight, conduit from the ground up to the signal cable/power access door located on the back of the

scoreboard. Here, it must pass through a rain-tight conduit fitting where it will connect to the signal cable terminal block inside the scoreboard.

## **RUNNING/CONNECTING THE ELECTRICAL SERVICE**

**NOTE: IT IS RECOMMENDED TO HAVE A LICENSED ELECTRICIAN FOR THIS PORTION. IDEALLY, THE SCOREBOARD WILL BE POWERED FROM A DEDICATED 120-VOLT / 20 AMP CIRCUIT. ADDITIONALLY, SINCE THE SCOREBOARD'S POWER SHOULD BE TURNED OFF AFTER EACH USE, THERE SHOULD BE EASY ACCESS TO THE POWER SWITCH OR CIRCUIT BREAKER. IF ACCESS TO THE CIRCUIT BREAKER IS NOT AN OPTION, INSTALL A SWITCH SOMEWHERE THAT IS ACCESSIBLE, EVEN IF UNDER THE SCOREBOARD AT AN ABOVE AVERAGE HEIGHT.**

1. The scoreboard has a ½” knock-out on the lower right corner for bringing in the electrical service. It can be enlarged if the conduit size is ¾”. This is where the conduit from the power source needs to terminate.

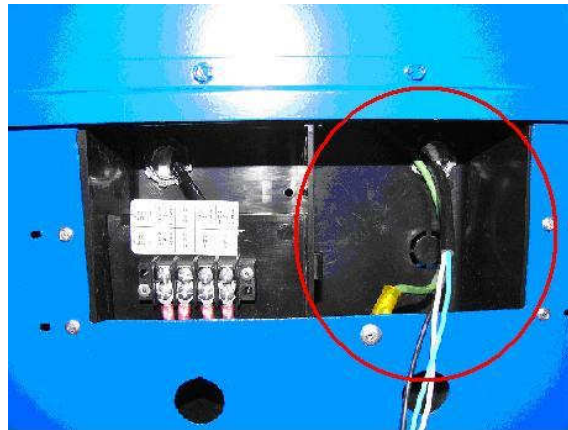

2. The connections are standard black, white, and green (ground). Replace the cover when complete.

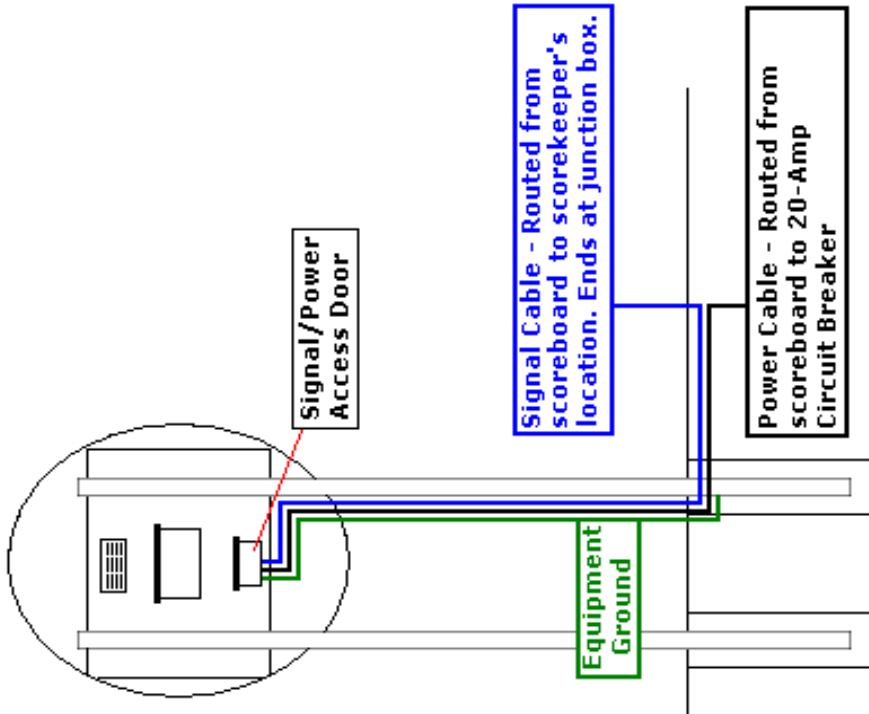
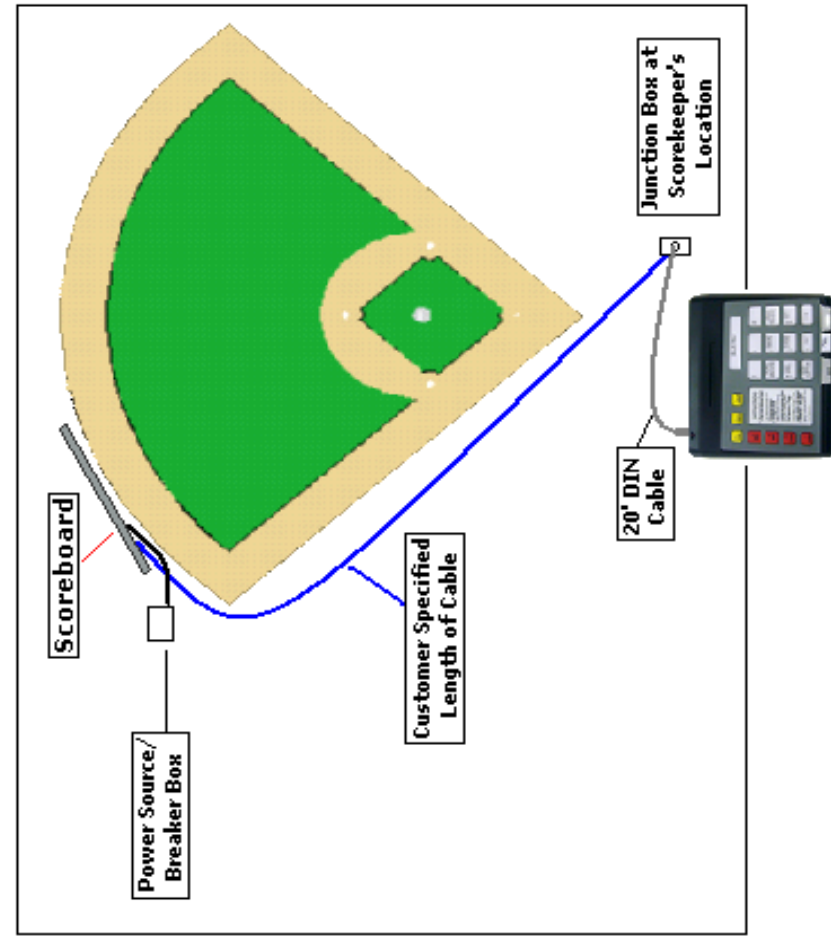

**IMPORTANT, PLEASE NOTE:**

1. Electrical connections should be performed by a licensed, qualified electrician in accordance with the product specifications, this diagram, and all building and electrical codes that apply to your area.
2. A water-tight, non-fusible disconnect with a 20-amp ground fault interrupt with equipment ground should be installed for each 20-amp circuit connected to the scoreboard.

# TESTING THE INSTALLED SYSTEM

**NOTE:** Please refer to the **OPERATORS MANUAL** on the CD, or included with the system to operate the scoreboard.

## Connecting cable-controlled systems:

Connect one end of the supplied 20-ft. control cable into either of the two control cable jacks on the back of the controller and the other into the receptacle on the supplied junction box cover installed at the scorekeeper's location.

## Connecting wireless systems:

Connect the wireless transmitter to the controller using the interface cable by plugging the large end of the interface cable into either of the control cable jacks on the back of the controller.

## Testing the scoreboard system:

1. Connect the appropriate end of the 12-volt DC wall transformer to the power receptacle on the back of the controller. Plug the transformer into a live, 120-volt outlet. If the optional battery pack was purchased with the keyboard, the transformer is also used to charge the battery.
2. Turn the power to the scoreboard *ON* using the power disconnect switch or circuit breaker. The **BALL, STRIKE AND OUT** displays should read "0" and the total **RUNS SHOULD READ "0"** with the rest of the scoreboard blank.
3. With the controller *OFF*, press and hold the **OPTION** key while turning the controller *ON*. The controller's LCD will briefly display the controller's software version. When the display changes and reads "**SELECT DIAG MODE <DIGIT TEST>**," press **ENTER**. The LCD will now read "**SEGMENT TEST – SEGMENTS OFF.**"
4. **NOTE: None of the scoreboards components should be lit at this time. If any components are lit, especially with a solid "8", check the crossover connections between cabinets. Ensure that the red stripes on the ribbon cables are matched where they are connected.**
5. Pressing the **UP** arrow (located on the far right of the controller's keypad) will cycle the scoreboard into "digit count" mode and all displays on the scoreboard will count 0-9 repetitively. Pressing the **UP** arrow again will cycle to "**<ALL ON>**", and all components should display an "8". At this time, take a look at the segments of each component for LEDs that are not lit.
6. To exit the diagnostic mode, press the **RESET** key twice.
7. If all components pass this test, the installation is complete.

**NOTE:** Always turn both the controller and the scoreboard *OFF* after each use. If the controller is turned *OFF* but the scoreboard remains *ON*, (or if the controller loses communication with the scoreboard), the scoreboard's *STRIKE* digit will begin to flash. This feature is intended to remind the user to turn power to the scoreboard *OFF* after each use

# IMPORTANT!

## Warranty Activation/Installation & Completion Sign Off Sheet

NOTE: This sheet must be completely filled out and returned/faxed (270) 753-3773 to Scoreboard Service Company before your warranty can be activated.

Your Serial Number \_\_\_\_\_

Your Model Number \_\_\_\_\_

Date Purchased \_\_\_\_\_

Sales Agent \_\_\_\_\_

Person Authorizing Purchase (title) \_\_\_\_\_

Date Installation Completed \_\_\_\_\_

Company or Person Responsible  
For Installation (address/phone number) \_\_\_\_\_

---

This document confirms that the installation for the 8-ft x 20-ft Baseball Scoreboard has been completed. All structural, wiring, and power requirements have been met. This unit has been powered on, tested in diagnostic and game modes ensuring the functionality of the unit.

\_\_\_\_\_

Scoring/timing equipment responsible party

\_\_\_\_\_

Installer

So that we may better serve you, please have this information available in the event you need to call technical support. Customer Service: 1-800-411-3136