

FRONT VIEW

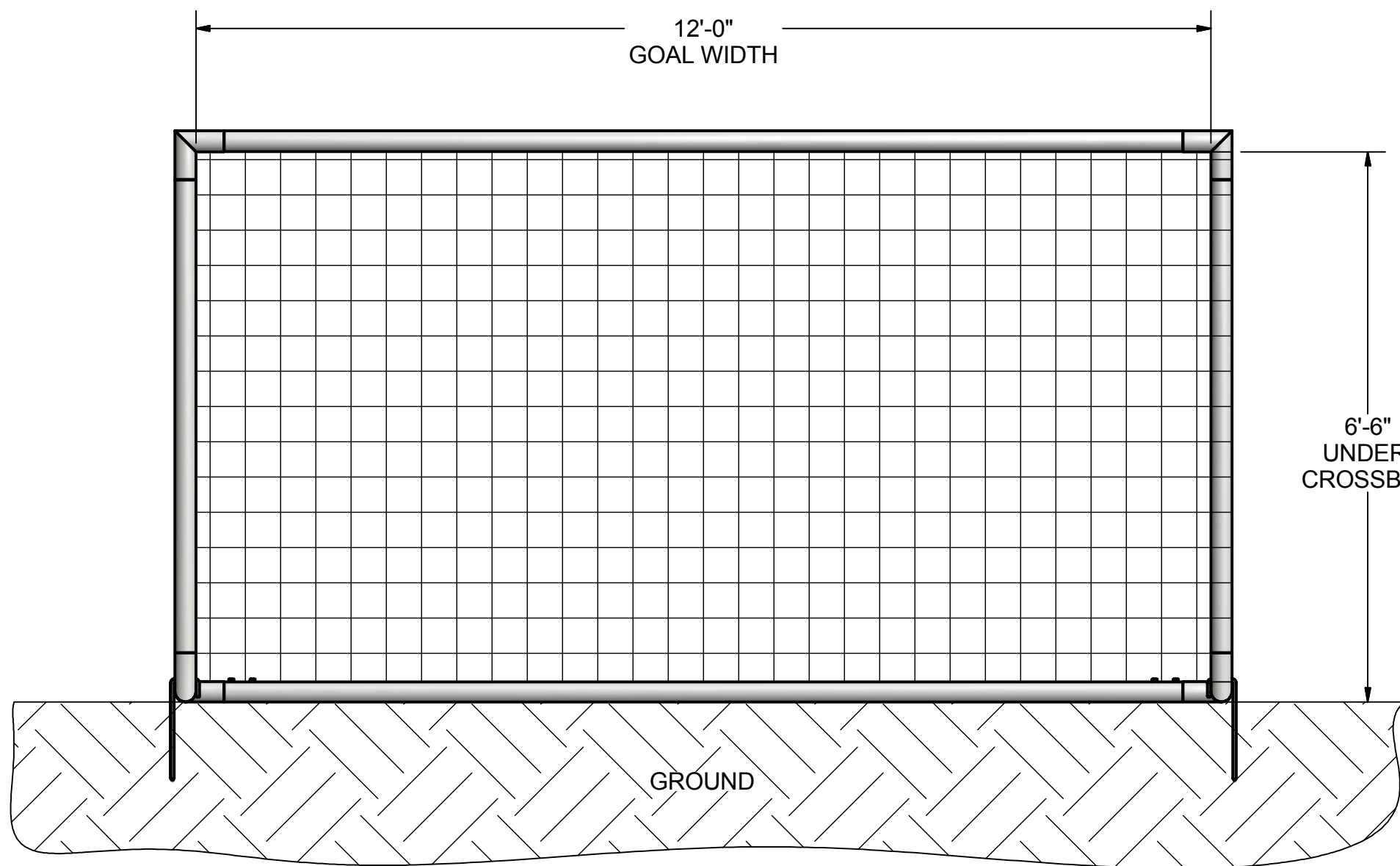

SIDE VIEW

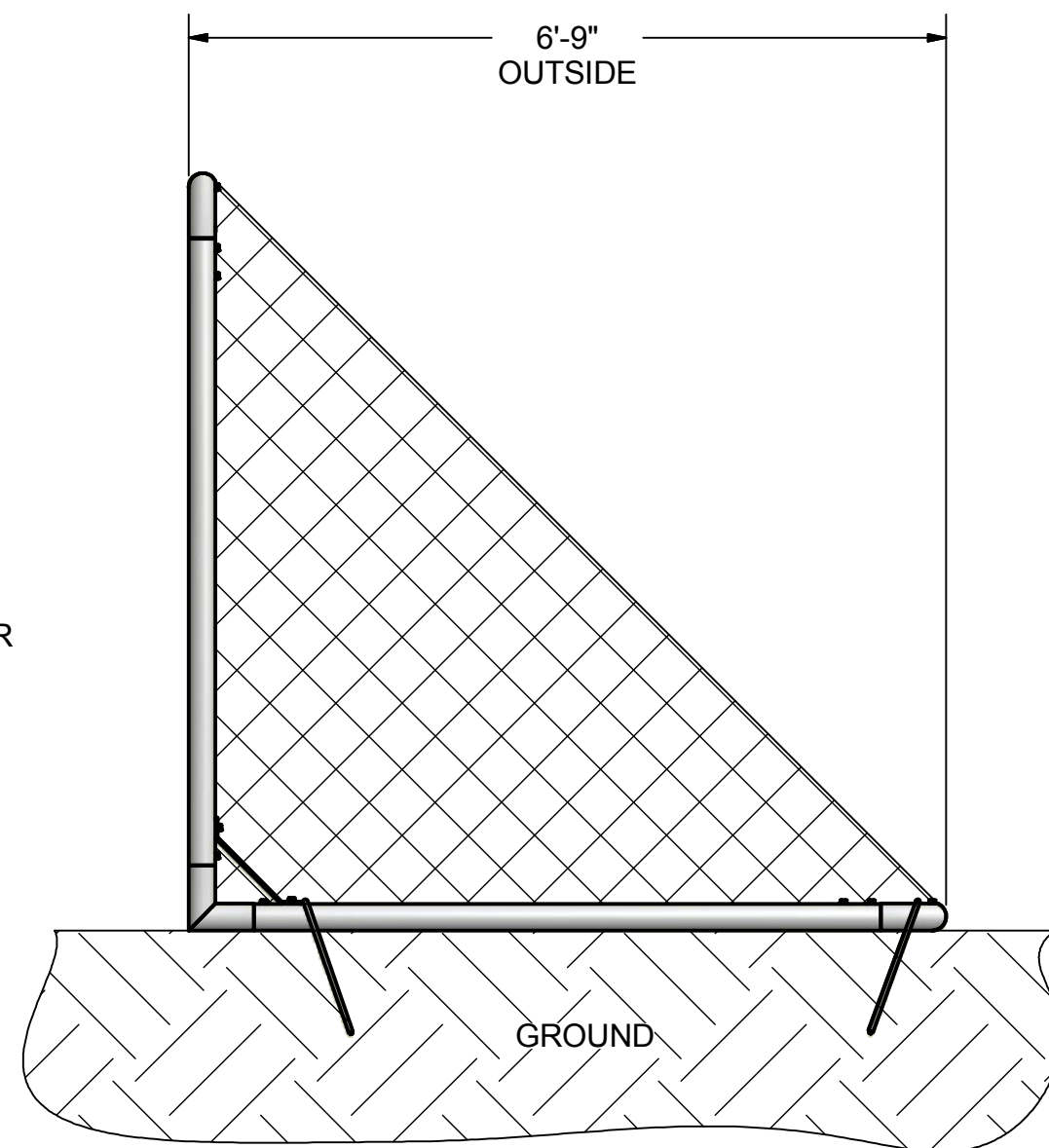

FEATURES:

- 1) ALUMINUM GOAL FRAME
- 2) FINISH: WHITE POWDER COAT
- 3) INCLUDED:
 - J- ANCHORS
 - 2.4mm, ORANGE NET
 - NET ATTACHMENT STRAPS
- 4) ASSEMBLED GOAL WEIGHT: 65 LBS.
- 5) ASTM F2056-00 STANDARD:
 - THIS GOAL DOES NOT FALL UNDER THE SCOPE
 - OF ASTM F2056-00 BECAUSE OF IT'S SIZE AND/OR WEIGHT

Finish Info.

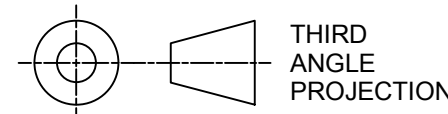

DIMENSIONS ARE IN INCHES
UNLESS OTHERWISE SPECIFIED

This item is the **exclusive**
property of **KWIK GOAL LTD.**
Reproduction or duplication
without the express written
consent of **KWIK GOAL LTD.**
is **strictly forbidden.**



Approved By:

Date:

Drawn By: BRush

Date: 7/18/2006

Sheet: 1 of 4

Revision #: 3

Cad File: 2B5003.idw

Part #:
2B5003

Desc:
6-1/2'H X 12'W X 0'D X
6-3/4'B ACADEMY GOAL

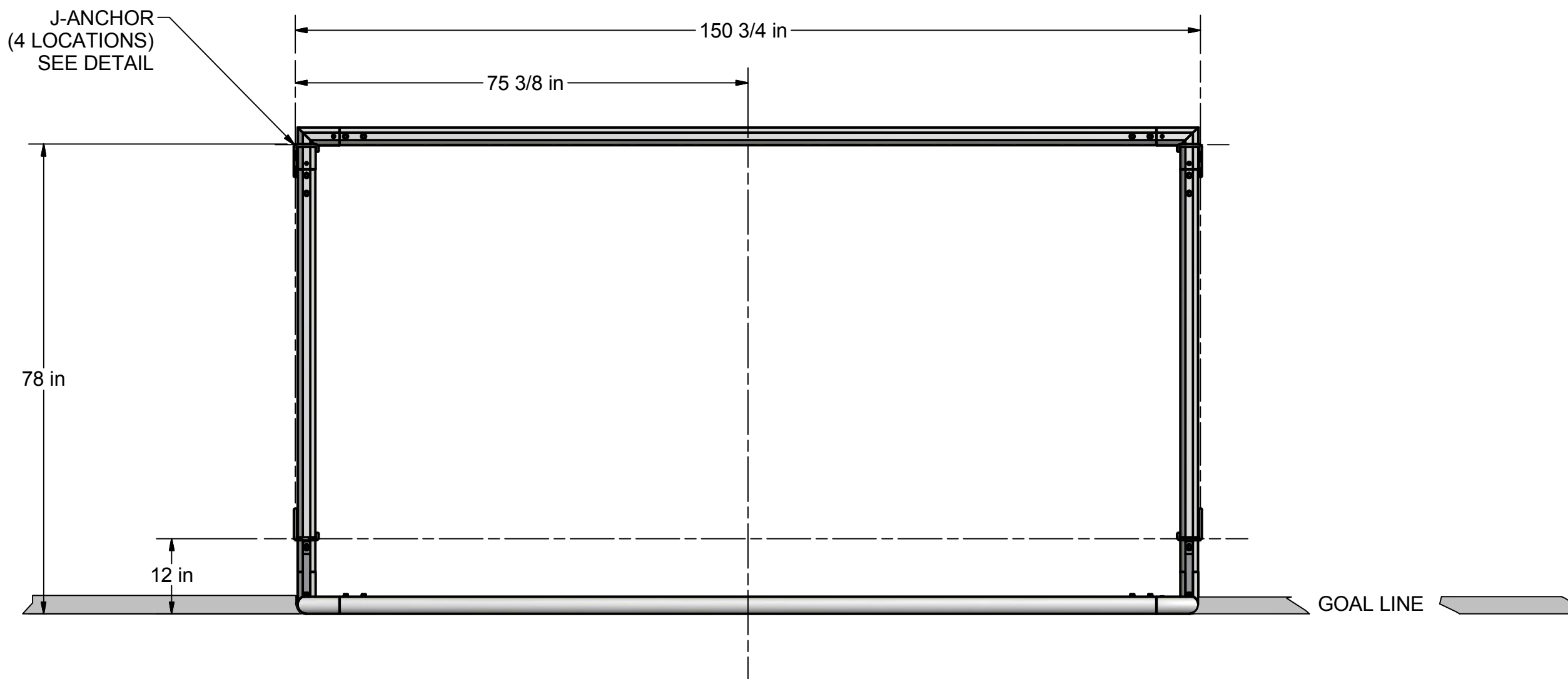

OVERHEAD VIEW

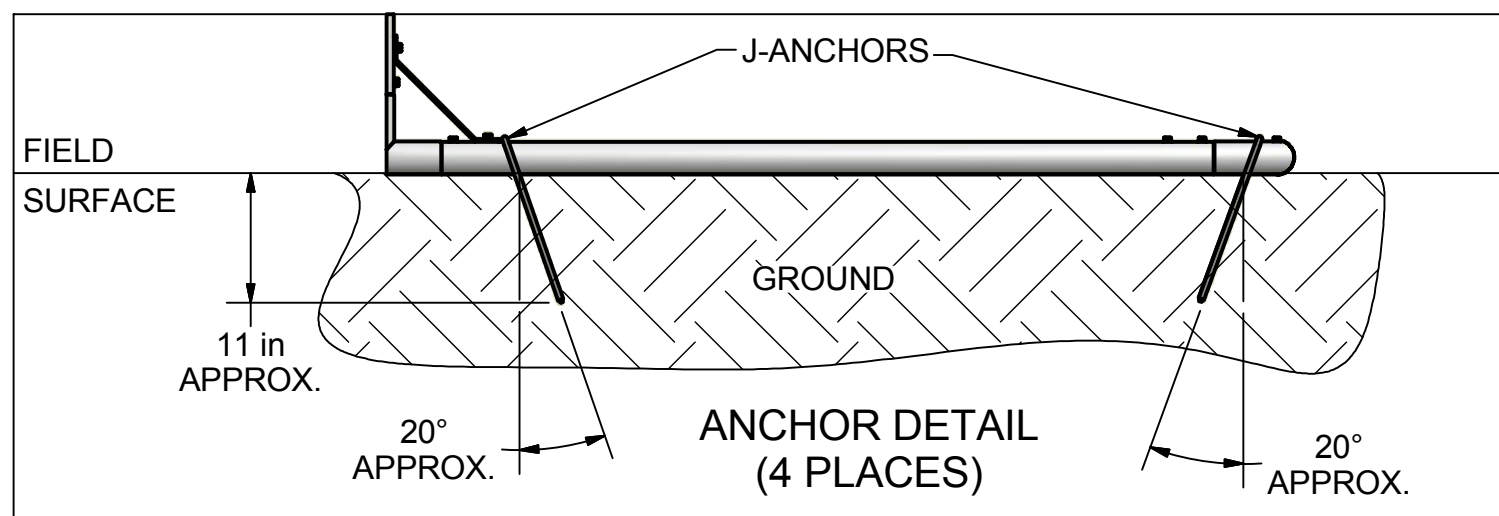

NOTES:

- 1) DIMENSIONS ARE FOR PLANNING PURPOSES. INSTALLATION MUST BE IN ACCORDANCE WITH INSTALLATION INSTRUCTIONS.

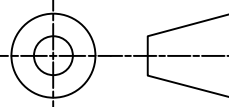

 THIRD ANGLE PROJECTION	 KWIKGOAL [®] 140 Pacific Drive Quakertown, Pa. 18951	
	DIMENSIONS ARE IN INCHES UNLESS OTHERWISE SPECIFIED	Approved By: Date:
This item is the exclusive property of KWIK GOAL LTD. Reproduction or duplication without the express written consent of KWIK GOAL LTD. is strictly forbidden.	Drawn By: BRush Date: 7/18/2006	Desc: 6-1/2'H X 12'W X 0'D X 6-3/4'B ACADEMY GOAL
	Sheet: 2 of 4 Revision #: 3	
	Cad File: 2B5003.idw	

Finish Info.

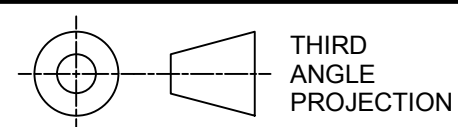
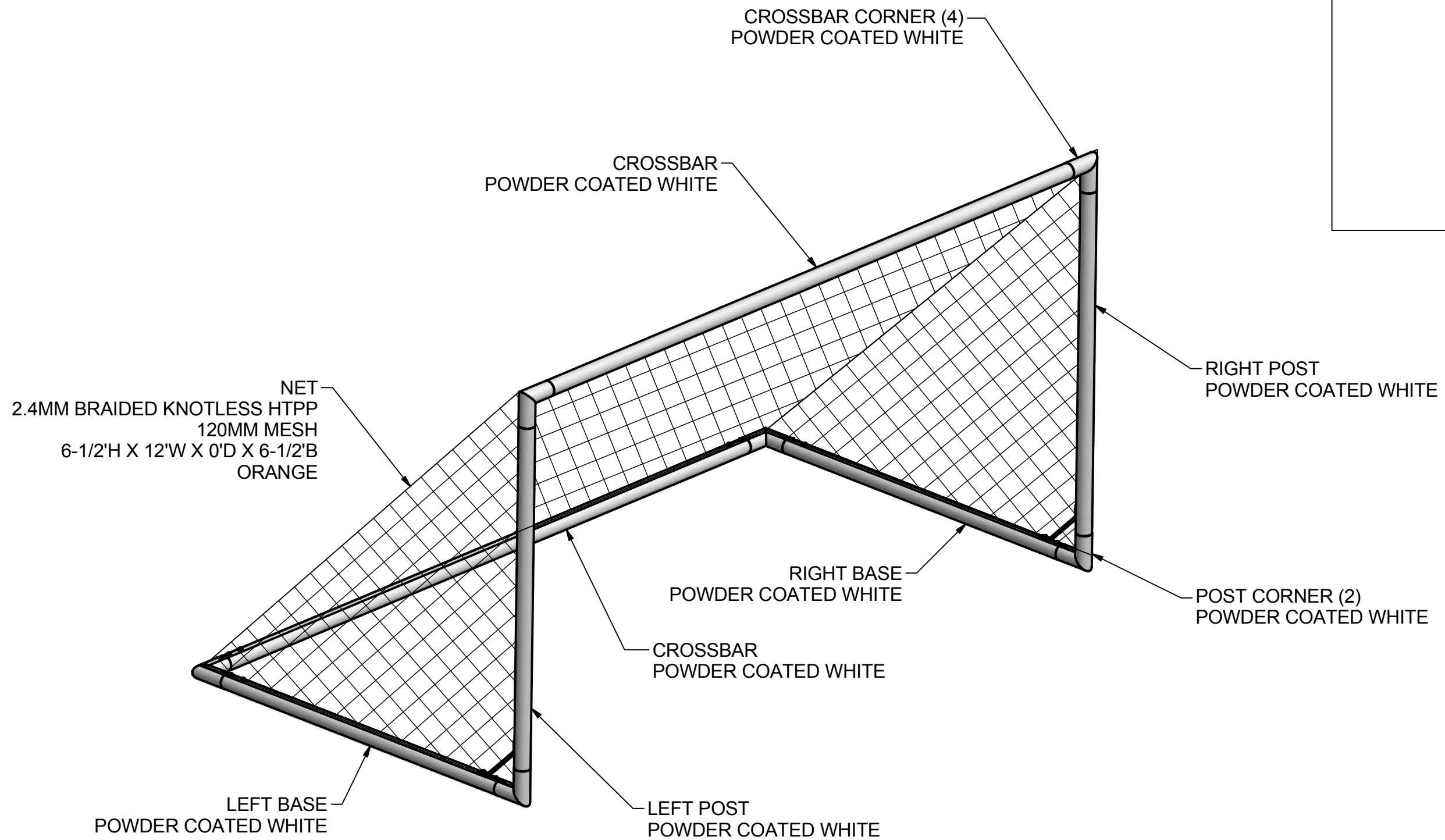
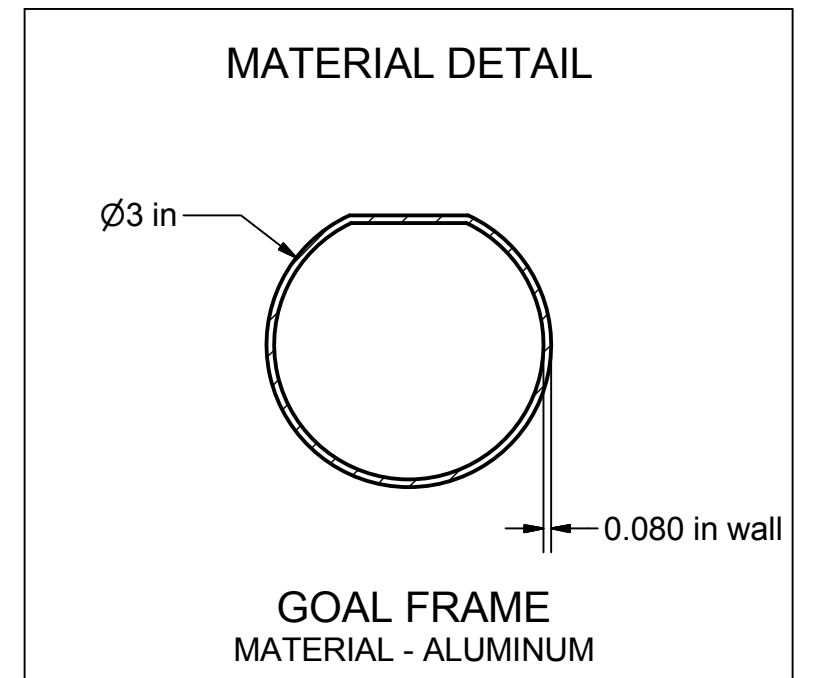

KWIKGOAL® 140 Pacific Drive
Quakertown, Pa. 18951

DIMENSIONS ARE IN INCHES
UNLESS OTHERWISE SPECIFIED

Approved By:
Date:

Part #:
2B5003

This item is the **exclusive** property of **KWIK GOAL LTD.** Reproduction or duplication **without** the express written consent of **KWIK GOAL LTD.** is **strictly forbidden.**

Drawn By: BRush
Date: 7/18/2006
Sheet: 3 of 4
Revision #: 3
Cad File: 2B5003.idw

Desc:
6-1/2'H X 12'W X 0'D X 6-3/4'B ACADEMY GOAL

Finish Info.

Parts List		
Part #	Qty	Description
UZ1016	2	CROSSBAR, 2B5003
UZ1017	1	POST, 2B5003
UZ1018	3	BASE, 2B5003/4
UZ1006	4	CORNER ASSEMBLY, CROSSBAR
UZ1008	2	CORNER ASSEMBLY, POST
UZ1029	4	ANCHOR PEG, J-STYLE
UZ737	2	FRONT POST BRACE
3B3511	1	NET, SOCCER GOAL

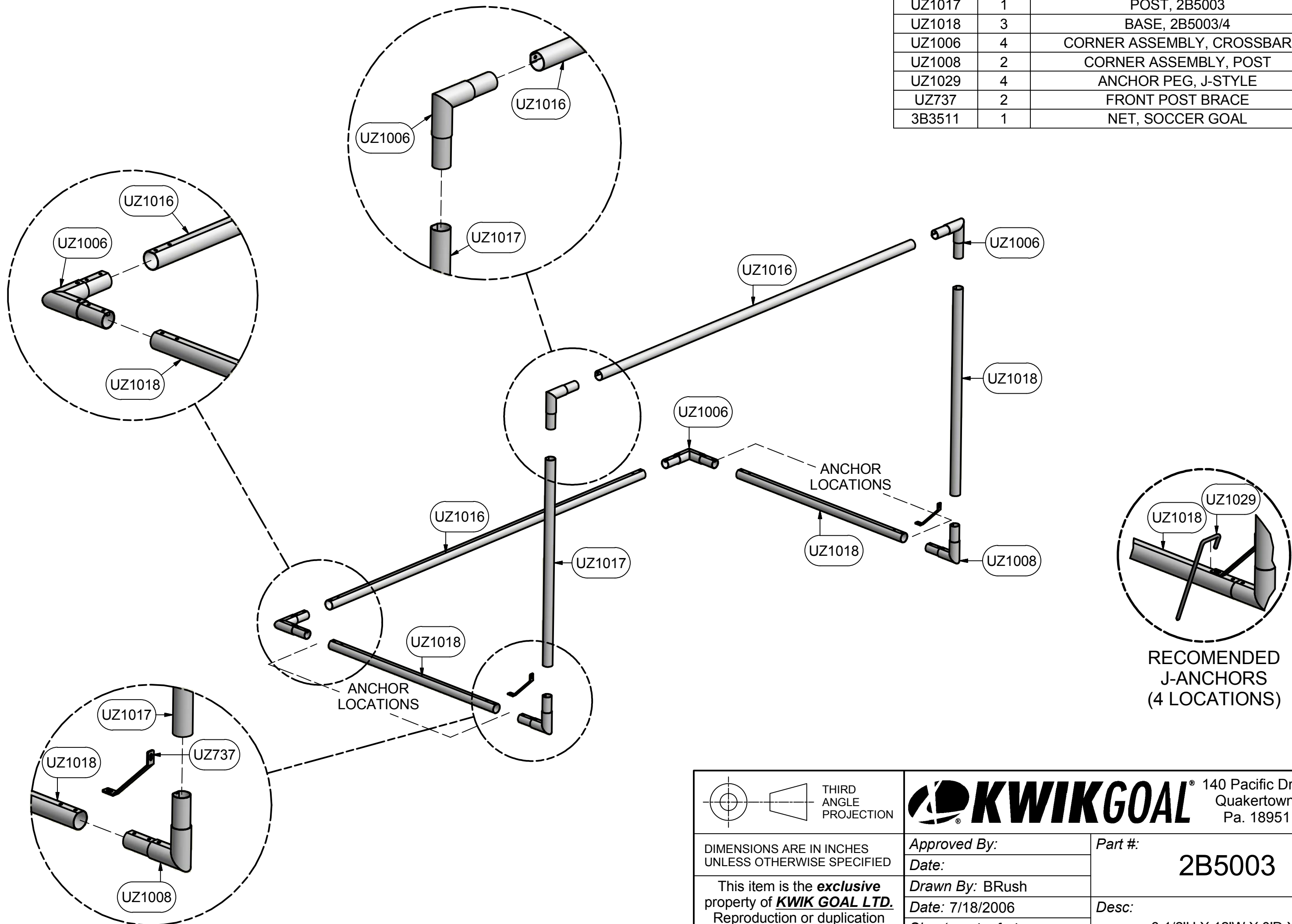

Finish Info.

<p>THIRD ANGLE PROJECTION</p>	<p>140 Pacific Drive Quakertown, Pa. 18951</p>	
	<p>DIMENSIONS ARE IN INCHES UNLESS OTHERWISE SPECIFIED</p>	<p>Approved By:</p> <p>Date:</p>
<p>This item is the exclusive property of KWIK GOAL LTD. Reproduction or duplication without the express written consent of KWIK GOAL LTD. is strictly forbidden.</p>	<p>Drawn By: BRush</p> <p>Date: 7/18/2006</p> <p>Sheet: 4 of 4</p> <p>Revision #: 3</p> <p>Cad File: 2B5003.idw</p>	<p>Desc:</p> <p>6-1/2'H X 12'W X 0'D X 6-3/4'B ACADEMY GOAL</p>

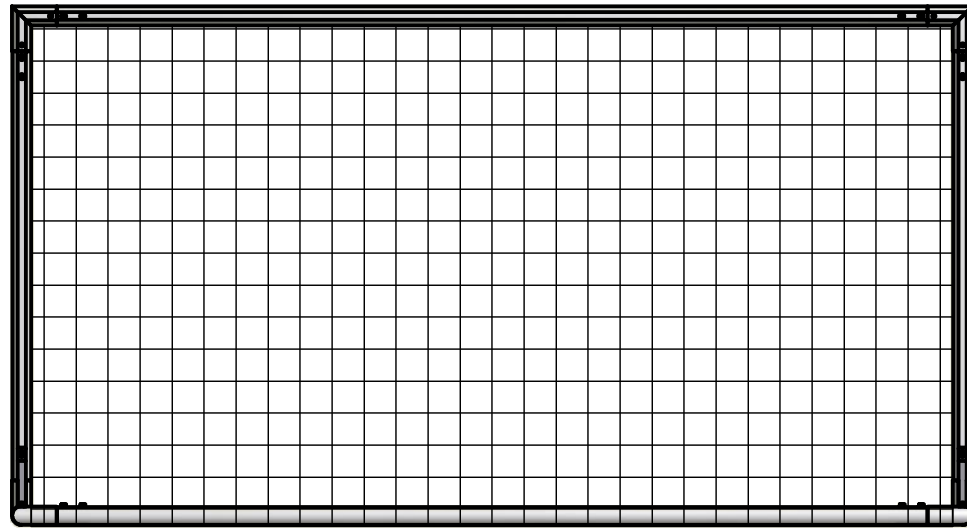

KWIK GOAL LTD.
2B5003
TOP VIEW

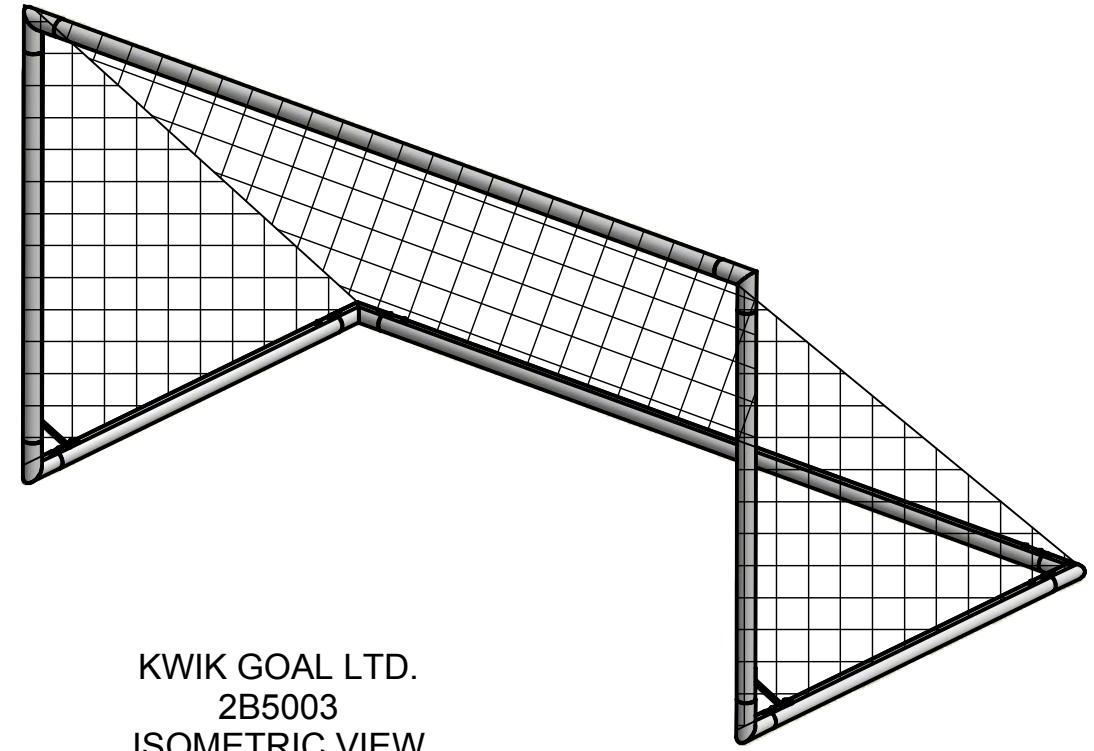

KWIK GOAL LTD.
2B5003
ISOMETRIC VIEW

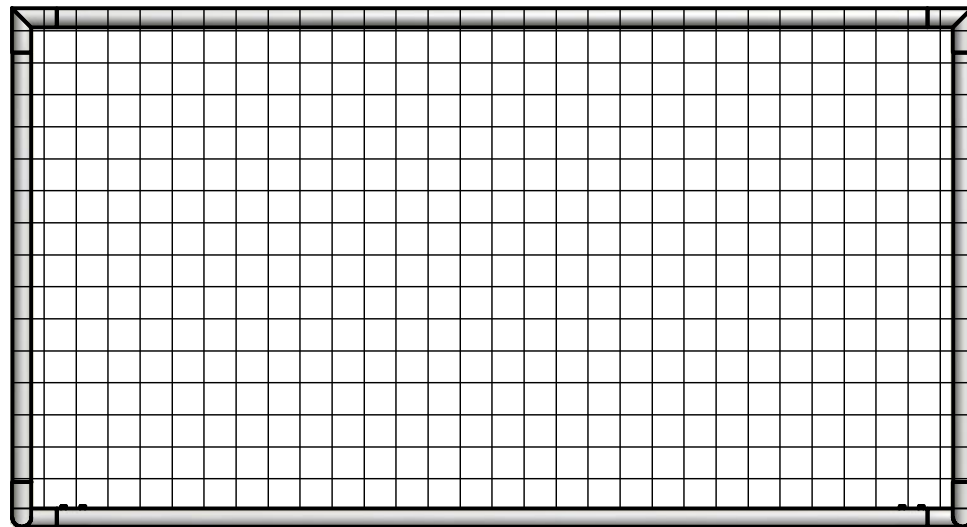

KWIK GOAL LTD.
2B5003
FRONT VIEW

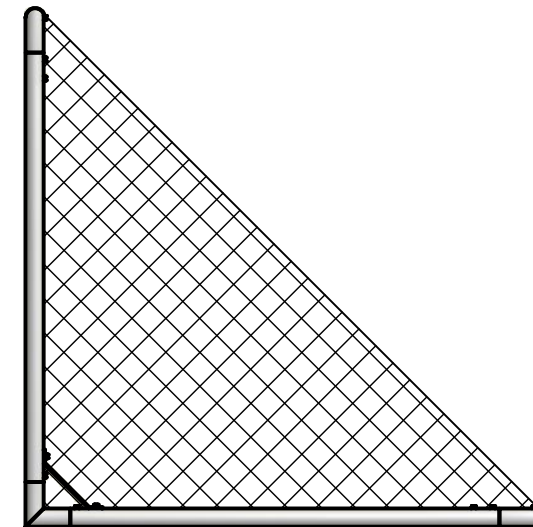

KWIK GOAL LTD.
2B5003
RIGHT VIEW

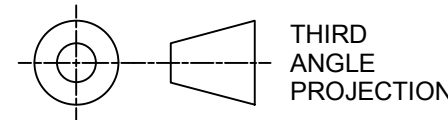

THIRD
ANGLE
PROJECTION

KWIKGOAL® 140 Pacific Drive
Quakertown,
Pa. 18951

DIMENSIONS ARE IN INCHES
UNLESS OTHERWISE SPECIFIED

Approved By:
Date:

Part #:
2B5003

This item is the **exclusive**
property of **KWIK GOAL LTD.**
Reproduction or duplication
without the express written
consent of **KWIK GOAL LTD.**
is **strictly forbidden.**

Drawn By: BRush
Date: 7/18/2006
Sheet: of 4
Revision #: 3
Cad File: 2B5003.idw

Desc:
6-1/2'H X 12'W X 0'D X
6-3/4'B ACADEMY GOAL

Finish Info.