

FRONT VIEW

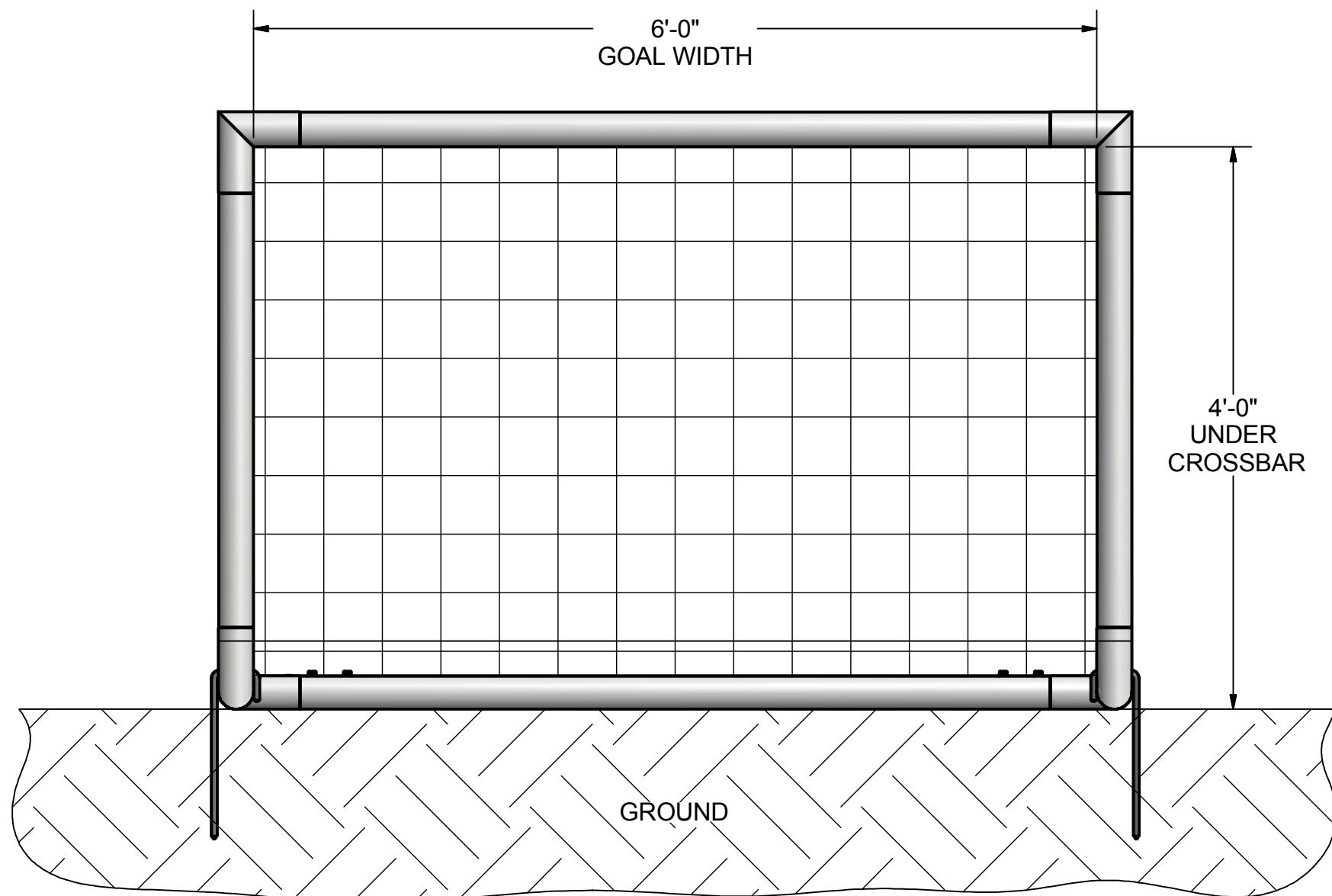

SIDE VIEW

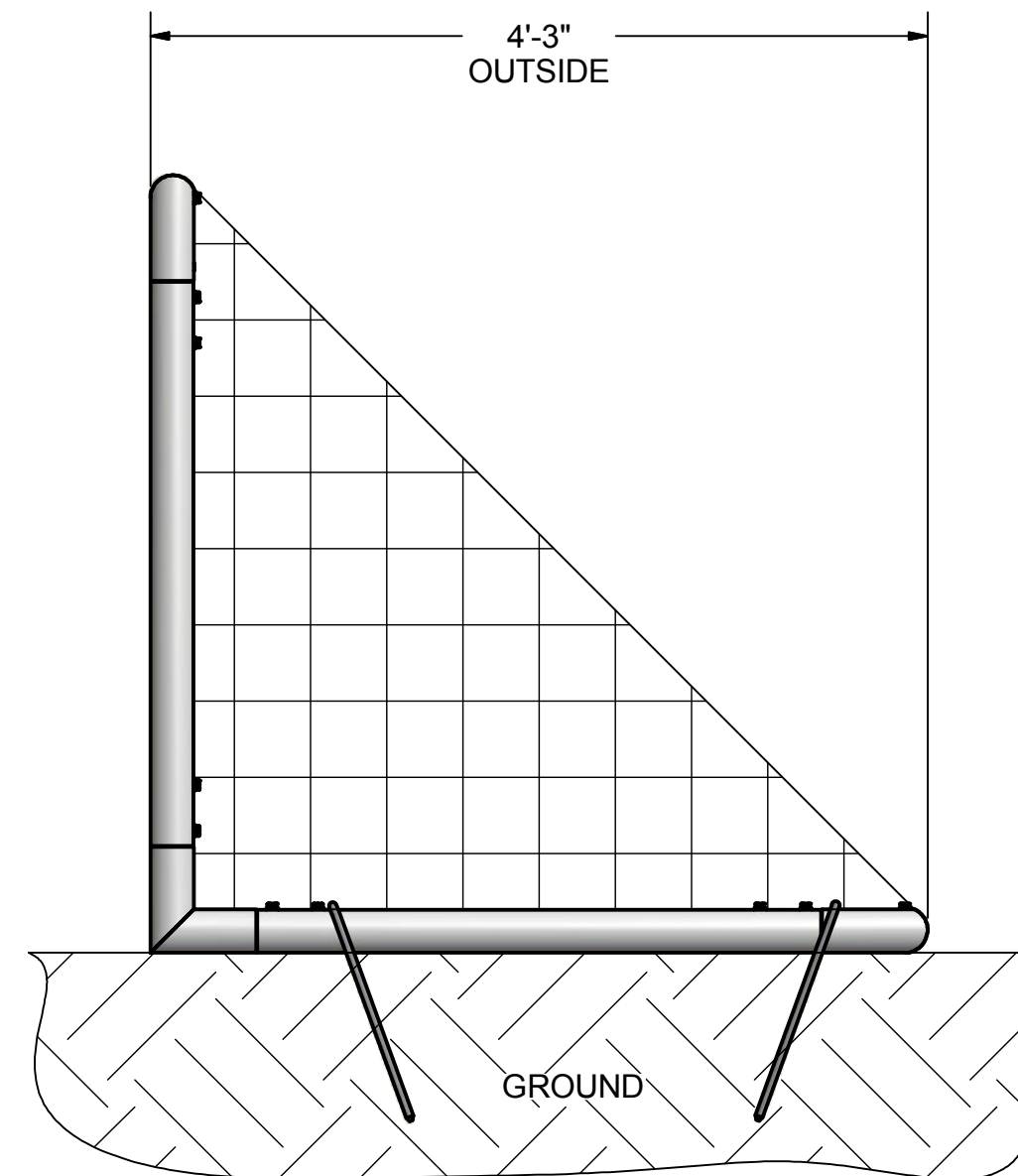

FEATURES:

- 1) ALUMINUM GOAL FRAME
- 2) FINISH: WHITE POWDER COAT
- 3) INCLUDED:
 - J- ANCHORS
 - 2.4mm, ORANGE NET
 - NET ATTACHMENT STRAPS
- 4) ASSEMBLED GOAL WEIGHT: 43 LBS.
- 5) THIS GOAL DOES NOT FALL UNDER THE SCOPE OF ASTM F2056-00 BECAUSE OF IT'S SIZE AND/OR WEIGHT

Finish Info.

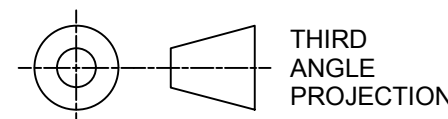

KWIKGOAL® 140 Pacific Drive
Quakertown, Pa. 18951

DIMENSIONS ARE IN INCHES UNLESS OTHERWISE SPECIFIED

Approved By:
Date:

Part #:
2B5001

This item is the **exclusive** property of **KWIK GOAL LTD.** Reproduction or duplication **without** the express written consent of **KWIK GOAL LTD.** is **strictly forbidden.**

Drawn By: KFrish
Date: 2/1/2011
Sheet: 1 of 4
Revision #: 2
Cad File: 2B5001.idw

Desc:
4'H X 6'W X 0'D X 4-1/4'B
ACADEMY GOAL

OVERHEAD VIEW

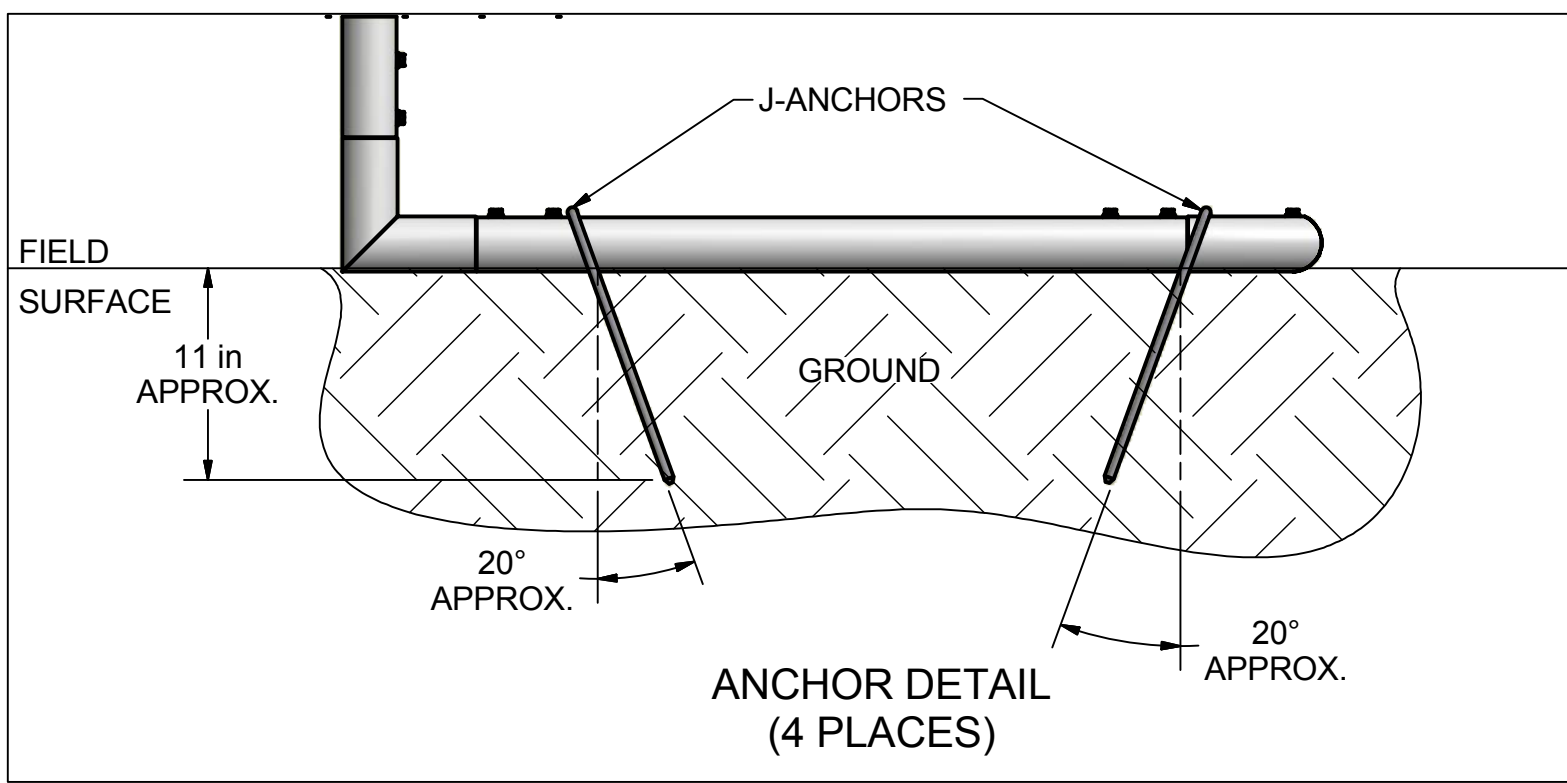
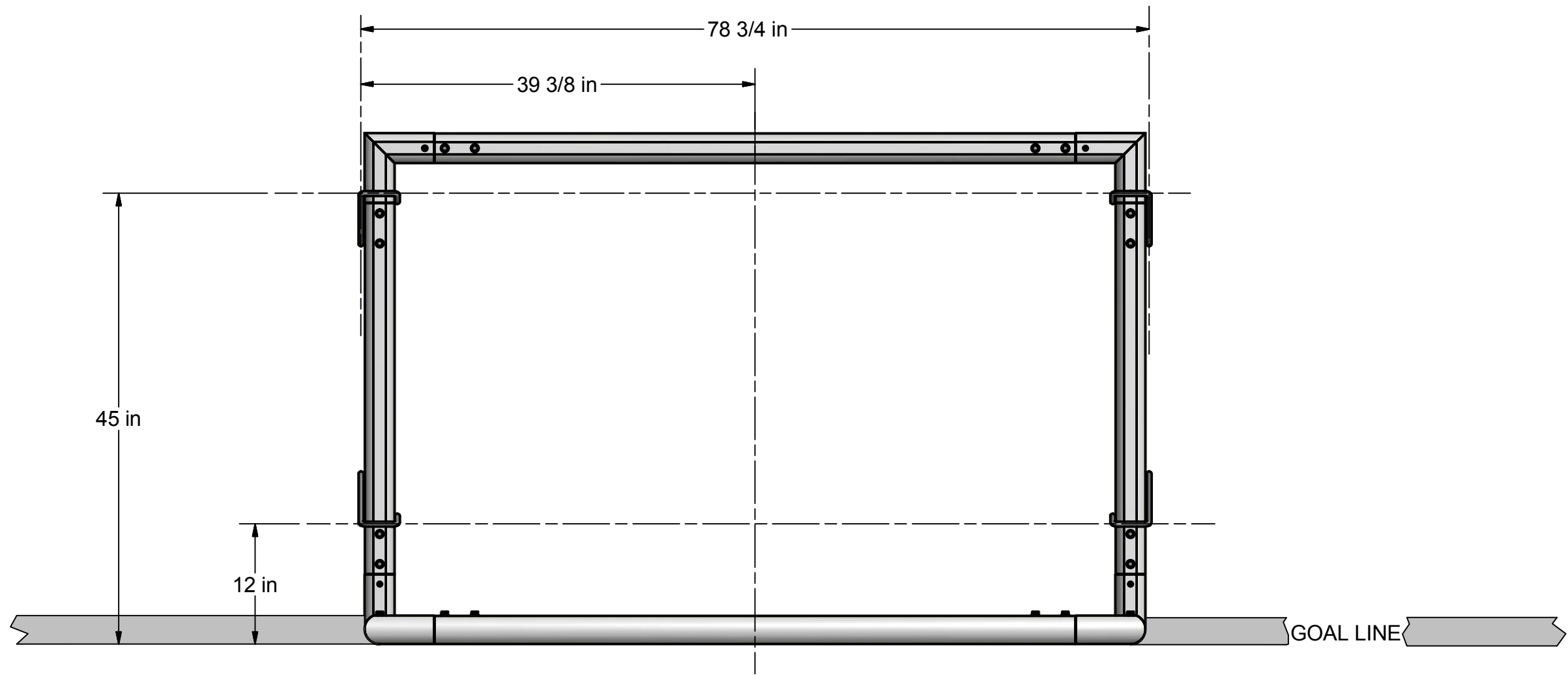

NOTES:

- 1) DIMENSIONS ARE FOR PLANNING PURPOSES. INSTALLATION MUST BE IN ACCORDANCE WITH INSTALLATION INSTRUCTIONS.

 THIRD ANGLE PROJECTION	 KWIKGOAL [®] 140 Pacific Drive Quakertown, Pa. 18951	
	DIMENSIONS ARE IN INCHES UNLESS OTHERWISE SPECIFIED	Approved By: Date:
This item is the exclusive property of KWIK GOAL LTD. Reproduction or duplication without the express written consent of KWIK GOAL LTD. is strictly forbidden.	Drawn By: KFrish Date: 2/1/2011	Desc: 4'H X 6'W X 0'D X 4-1/4'B ACADEMY GOAL
	Sheet: 2 of 4 Revision #: 2	
	Cad File: 2B5001.idw	

Finish Info.

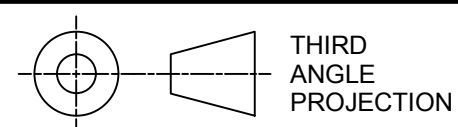
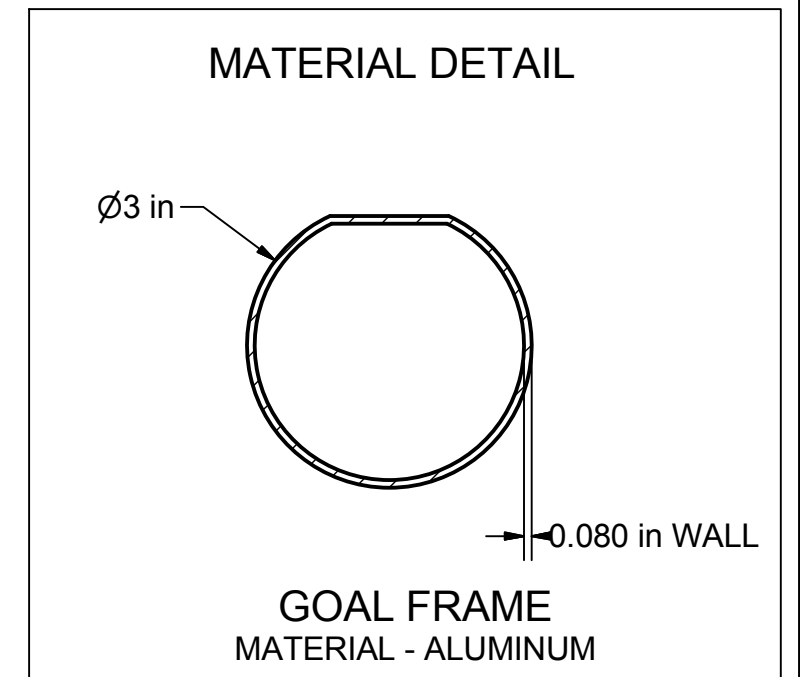
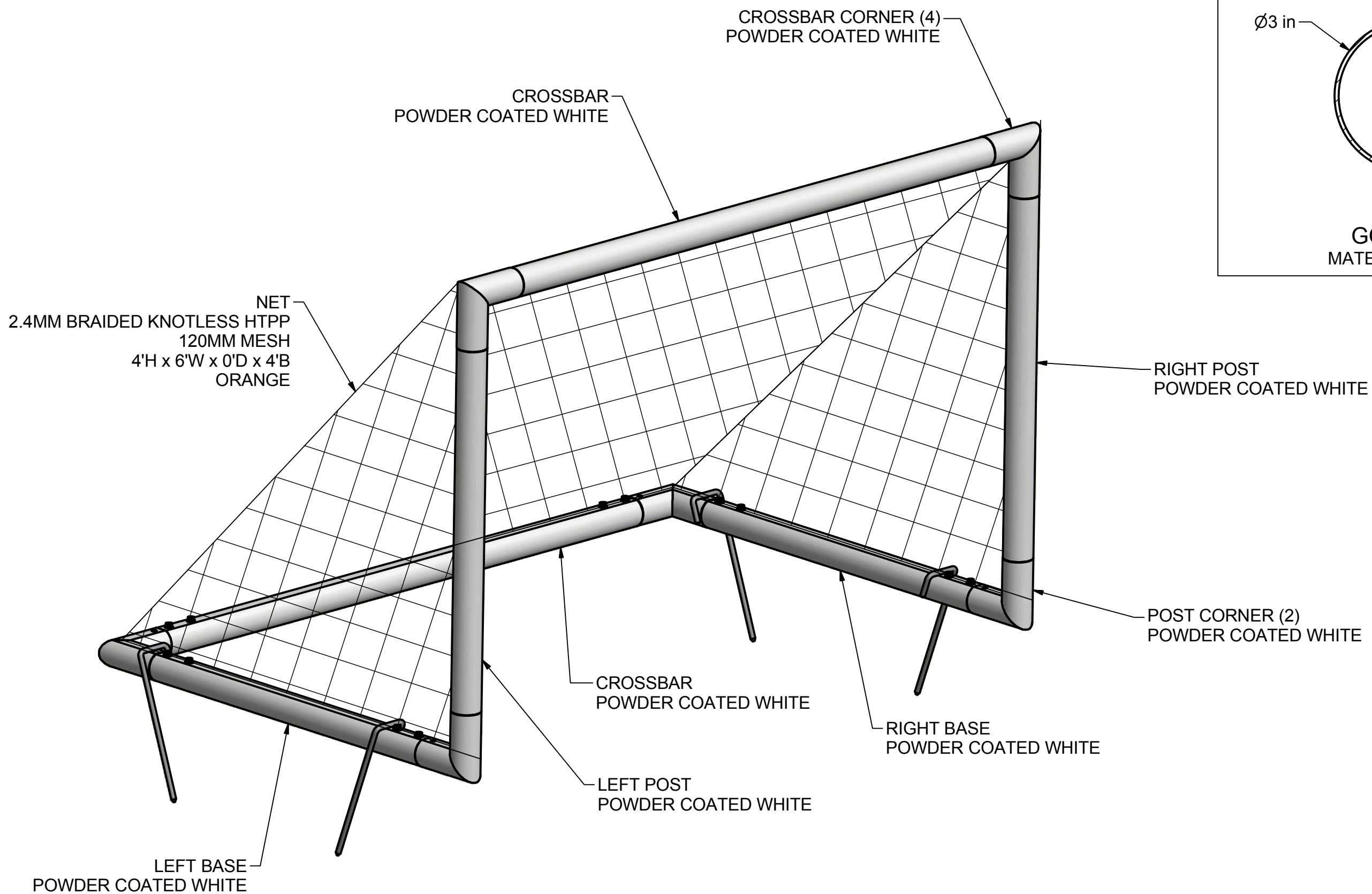

KWIKGOAL® 140 Pacific Drive
Quakertown, Pa. 18951

DIMENSIONS ARE IN INCHES UNLESS OTHERWISE SPECIFIED

Approved By:
Date:

Part #:
2B5001

This item is the **exclusive** property of **KWIK GOAL LTD.** Reproduction or duplication **without** the express written consent of **KWIK GOAL LTD.** is **strictly forbidden.**

Drawn By: KFrish
Date: 2/1/2011
Sheet: 3 of 4
Revision #: 2
Cad File: 2B5001.idw

Desc:
4'H X 6'W X 0'D X 4-1/4'B
ACADEMY GOAL

Finish Info.

Parts List		
Part #	Qty	Description
UZ1010	2	CROSSBAR, 2B5001
UZ1011	1	POST, 2B5001
UZ1012	3	BASE, 2B5001
UZ1006	4	CORNER ASSEMBLY, CROSSBAR
UZ1008	2	CORNER ASSEMBLY, POST
UZ1029	4	ANCHOR PEG, J-STYLE
10B9001	1	"J" STYLE ANCHOR PEG, SET OF 4
3B3311	1	NET, SOCCER GOAL

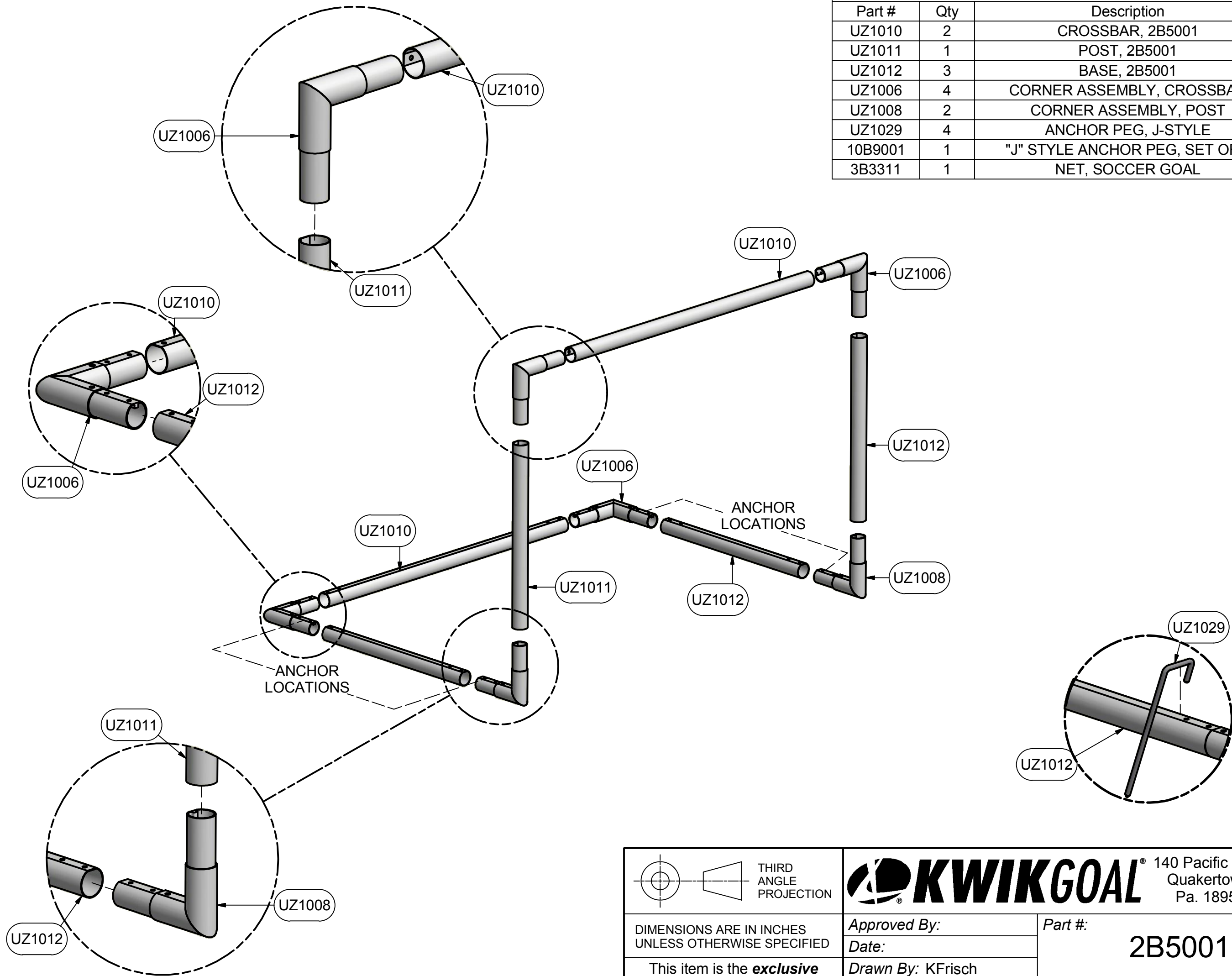

Finish Info.

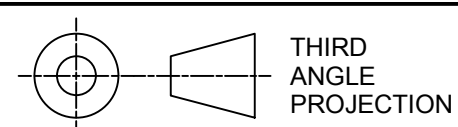

KWIKGOAL® 140 Pacific Drive
Quakertown, Pa. 18951

DIMENSIONS ARE IN INCHES
UNLESS OTHERWISE SPECIFIED

Approved By:
Date:

Part #:
2B5001

This item is the **exclusive** property of **KWIK GOAL LTD.** Reproduction or duplication **without** the express written consent of **KWIK GOAL LTD.** is **strictly forbidden.**

Drawn By: KFrish
Date: 2/1/2011
Sheet: 4 of 4
Revision #: 2
Cad File: 2B5001.idw

Desc:
4'H X 6'W X 0'D X 4-1/4'B
ACADEMY GOAL

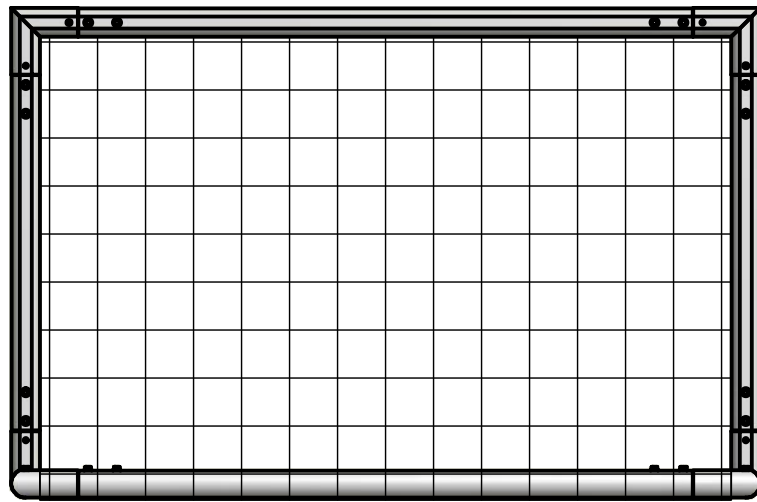

KWIK GOAL LTD.
2B5001
TOP VIEW

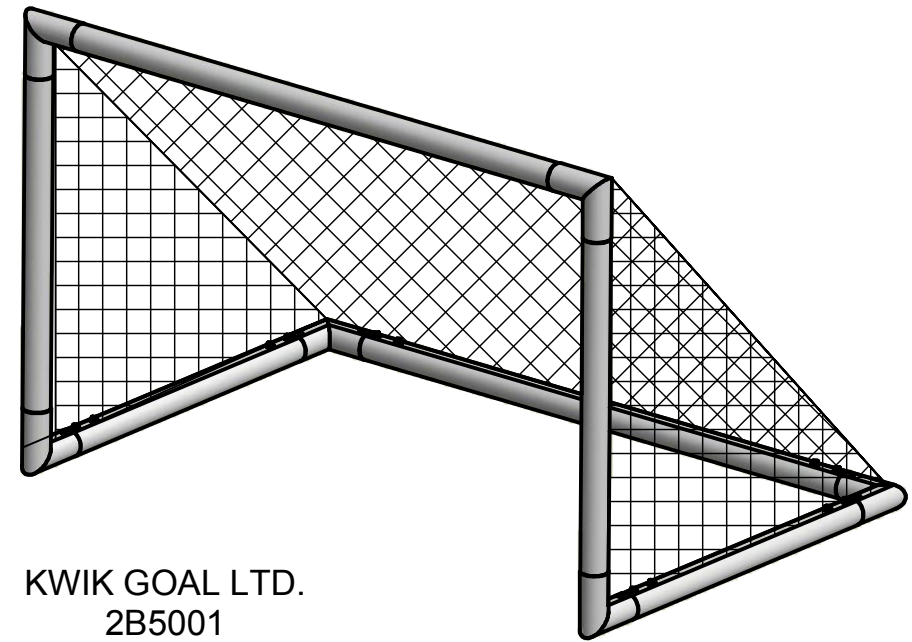

KWIK GOAL LTD.
2B5001
ISOMETRIC VIEW

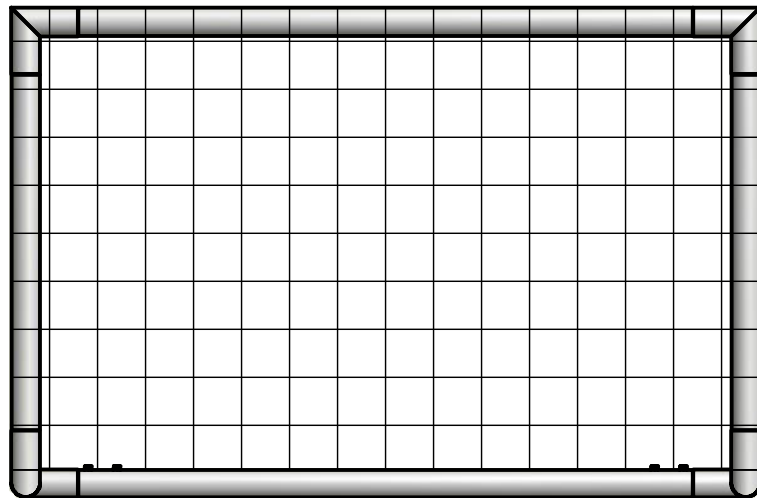

KWIK GOAL LTD.
2B5001
FRONT VIEW

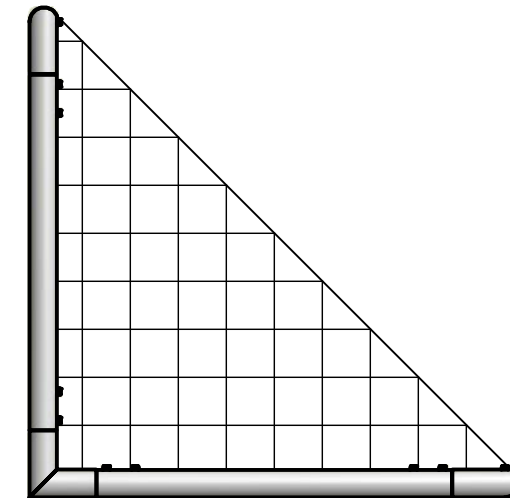

KWIK GOAL LTD.
2B5001
RIGHT VIEW

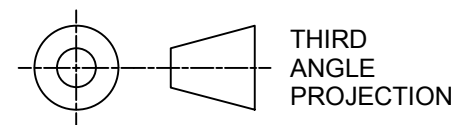

THIRD
ANGLE
PROJECTION



KWIKGOAL[®]

140 Pacific Drive
Quakertown,
Pa. 18951

DIMENSIONS ARE IN INCHES
UNLESS OTHERWISE SPECIFIED

Approved By:

Part #:

Date:

2B5001

This item is the **exclusive**
property of **KWIK GOAL LTD.**
Reproduction or duplication
without the express written
consent of **KWIK GOAL LTD.**
is **strictly forbidden.**

Drawn By: KFrish

Desc:

Date: 2/1/2011

Sheet: of 4

4'H X 6'W X 0'D X 4-1/4'B
ACADEMY GOAL

Revision #: 2

Cad File: 2B5001.idw

Finish Info.